

AquaCal®

Installation Manual

HEATWAVE  SUPERQUIET®



TropiCool
WATER CHILLER

SMART CONTROLLER ENABLED

Important

Read this document before operating / installing this product

For additional product manuals and operation / installation procedures, please visit www.AquaCal.com



MODEL / SERIAL NUMBER

Table of Contents

Contacting AquaCal AutoPilot, Inc.	1
Safety Instructions	1
1 - Installation	3
1.1 Positioning Equipment	4
1.2 Clearances	5
1.3 Dimensions	6
1.4 Plumbing	7
1.4.a Plumbing Requirements	7
1.4.b Plumbing Diagrams	7
1.4.c Water Connections to Heat Pump	10
1.4.d In-Line Chlorine Feeders	11
1.4.e Water Flow Rates	11
1.4.f Adjusting Water Flow Using ΔT (Delta-T)	13
1.4.g Maintaining Ability to Winterize	14
1.4.h Adjusting Water Pressure Switch	14
1.5 Electrical	15
1.5.a Electrical Requirements	15
1.5.b Incoming Power Access Holes	18
1.5.c Access Panels	19
1.5.d Verifying Transformer Setting	19
1.5.e Three-Phase Adjustment	20
1.5.f Schematic Location	20
1.6 External Equipment	21
1.6.a Connecting a Call Flex	21
1.6.b Connecting External Controllers to Heat Pump	23
b.1 Connecting Smart Bus Controllers	23
b.2 Connecting Two-wire Controllers (with internal thermostat)	28
1.6.c Connecting Gas Backup Heater to Heat Pump	30
1.6.d Connecting Multiple Heat Pumps (Master / Slaved)	36
1.6.e Connecting Optional Automatic Thermostat Switching	42
1.7 Program Heat Pump for the Customer	44
1.7.a Setting Date and Time	44
1.7.b Setting Date and Time Format	46
1.7.c Selecting Celsius or Fahrenheit	48
1.7.d Setting Entry Code Option	49
1.7.e Using Entry Code to Access Heat Pump	51
1.7.f Resetting Factory Defaults	52
1.8 Cleaning Equipment After Installation	53
2 - Troubleshooting	55
2.1 Fault Codes	55
2.2 Issues and Resolutions	61
3 - Appendix	68
3.1 Identifying Model Specifications	68
3.2 Weights	69
3.3 Heating Recommendations	69
3.4 Cooling Recommendations	70

Contacting AquaCal AutoPilot, Inc.

For further assistance, please contact the distributor or installer of this product.

If unavailable, please contact AquaCal® for a partner in your area. To better assist you, please have the heat pump model and serial number available.

- See "Identifying Model Specifications" on page 68.

Product Information:	
Website	www.AquaCal.com
Phone	(1) 727-823-5642
Hours	8-5 pm, Eastern M-F

Service Information:	
Website	www.AquaCal.com/request-heat-pump-service/

SAFETY INSTRUCTIONS

- For personal safety, and to avoid damage to equipment, follow all safety instructions displayed on the equipment and within this manual. Repair and service of heat pump must be performed by an authorized service center.
- Warranties may be voided if the equipment has been improperly installed, maintained or serviced.
- If service is deemed necessary, please see "Contacting AquaCal AutoPilot, Inc." on page 1.

SAFETY SIGNALS

Throughout this document, safety signals have been placed where particular attention is required.



Failure to heed the following will result in injury or death.



Failure to heed the following may result in injury or death.



Failure to heed the following may result in damage to equipment.

When installing and using your heat pump basic safety precautions must always be followed, including the following:



Failure to heed the following will result in injury or death.

- The heat pump utilizes high voltage and rotating equipment. Use caution when servicing.

WARNING

Failure to heed the following may result in injury or death.

- Installation and repairs must be performed by a qualified technician.
- The heat pump contains refrigerant under pressure. Repairs to the refrigerant circuit must not be attempted by untrained and / or unqualified individuals. Service must be performed only by qualified HVAC technicians. Recover refrigerant before opening the system.
- Improper water chemistry can present a serious health hazard. To avoid possible hazards, maintain pool / spa water per standards as detailed in the product's operation manual.
- Prolonged immersion in water warmer than normal body temperature may cause a condition known as Hyperthermia. The symptoms of Hyperthermia include unawareness of impending hazard, failure to perceive heat, failure to recognize the need to exit the spa, and unconsciousness. The use of alcohol, drugs, or medication can greatly increase the risk of fatal Hyperthermia. In addition, persons having an adverse medical history, or pregnant women, should consult a physician before using a hot tub or spa. Children and the elderly should be supervised by a responsible adult.
- Prolonged immersion in water colder than normal body temperature may cause a condition known as Hypothermia. The symptoms of Hypothermia include shivering (although as hypothermia worsens, shivering stops), clumsiness or lack of coordination, slurred speech or mumbling, confusion and poor decision-making, drowsiness or low energy, lack of concern about personal welfare, progressive loss of consciousness, weak pulse and slow or shallow breathing. In addition, persons having an adverse medical history, or pregnant women, should consult a physician before immersing in a cold body of water. Children and the elderly should be supervised by a responsible adult.

NOTICE

Failure to heed the following may result in damage to equipment.

- Maintain proper water chemistry in order to avoid damage to pump, filter, pool shell, etc.
- Water flow exceeding maximum flow rate requires a bypass. Damage due to excessive water flow will void warranty.

SAVE THESE INSTRUCTIONS

1 - Installation

WARNING

Failure to heed the following may result in injury or death.

- Installation of this equipment by anyone other than a qualified installer can result in a safety hazard.
- The information contained throughout the "Installation" section is intended for use by qualified installation technicians familiar with the swimming Pool / Spa safety standards.

NOTICE

Failure to heed the following may result in damage to equipment.

- Failure to protect equipment against corrosive conditions will adversely affect the life of the equipment and will void equipment warranty.

IN THIS SECTION:

1.1 Positioning Equipment	4
1.2 Clearances	5
1.3 Dimensions	6
1.4 Plumbing	7
1.4.a Plumbing Requirements	7
1.4.b Plumbing Diagrams	7
1.4.c Water Connections to Heat Pump	10
1.4.d In-Line Chlorine Feeders	11
1.4.e Water Flow Rates	11
1.4.f Adjusting Water Flow Using ΔT (Delta-T)	13
1.4.g Maintaining Ability to Winterize	14
1.4.h Adjusting Water Pressure Switch	14
1.5 Electrical	15
1.5.a Electrical Requirements	15
1.5.b Incoming Power Access Holes	18
1.5.c Access Panels	19
1.5.d Verifying Transformer Setting	19
1.5.e Three-Phase Adjustment	20
1.5.f Schematic Location	20
1.6 External Equipment	21
1.6.a Connecting a Call Flex	21
1.6.b Connecting External Controllers to Heat Pump	23
1.6.c Connecting Gas Backup Heater to Heat Pump	30
1.6.d Connecting Multiple Heat Pumps (Master / Slaved)	36
1.6.e Connecting Optional Automatic Thermostat Switching	42
1.7 Program Heat Pump for the Customer	44
1.7.a Setting Date and Time	44
1.7.b Setting Date and Time Format	46
1.7.c Selecting Celsius or Fahrenheit	48
1.7.d Setting Entry Code Option	49
1.7.e Using Entry Code to Access Heat Pump	51
1.7.f Resetting Factory Defaults	52
1.8 Cleaning Equipment After Installation	53

1.1 Positioning Equipment

NOTICE

Failure to heed the following may result in damage to equipment.

- Do not install equipment inside of a building.

Outdoor Use Only

Do not install equipment inside of a room or building.

- Heat Pumps require unobstructed air flow for proper operation. Heat Pumps should never be installed indoors or in a location where air flow is restricted.
- See "Clearances" on page 5.

Controlling Irrigation and Rainwater Runoff

- Irrigation water may damage heat pump components. Direct irrigation water away from the heat pump.
- The heat pump will withstand normal rainfall. Do not allow a roof slope to direct rainwater onto the heat pump. Have a gutter installed on the roof edge to direct this water away from the heat pump. Or install the heat pump in another location.

Planning for Condensation

The heat pump can produce a large amount of condensation. The amount of water depends on air temperature and humidity.

- Install the heat pump with enough height to allow for water drainage.
- Plan for water drainage as needed.
 - See "Condensation Drain Kit (# STK0202)" on page 70.

Mounting Pad Requirements

- The heat pump's base must be installed on a flat and level surface that completely supports the entire base.
- Build the heat pump pad out of concrete or other code-approved material.
- Confirm the pad can support the weight of the heat pump. See "Weights" on page 69.
- Elevate the pad enough to allow for drainage.
- Make sure the pad is flat and level.
- Have the pad extend at least 6 inches from the heat pump base in all directions.
- Do not install the heat pump on soil or grass.
- Do not allow the heat pump base to touch the building's foundation.
- Do not place the heat pump directly on a concrete floor. This can cause noise to be transmitted to an occupied space. If necessary install vibration dampers between the heat pump base and floor.
- Equipment pad must meet all requirements of authorities having code-related jurisdiction.

Anchoring to Pad

- Follow all applicable local, state, and national requirements regarding wind load anchoring.
- The shipping brackets used to secure the heat pump to the pallet are approved mounting (hurricane) brackets. They should be used to anchor the heat pump to the pad.
- If needed, contact AquaCal® to obtain anchoring kit information. Please have the heat pump model number and serial number when requesting support. See "Identifying Model Specifications" on page 68.

1.2 Clearances

- Proper air circulation is required for the heat pump to operate efficiently. The following diagrams show the minimum clearances required for the proper operation of the heat pump.
- Avoid storing chemical containers near the heat pump. The chemicals can cause equipment damage.
- Avoid placing objects near or on top of the heat pump. This includes shrubbery and lawn furniture. These objects will reduce performance and efficiency and hinder maintenance access.

(Overhead Clearance)

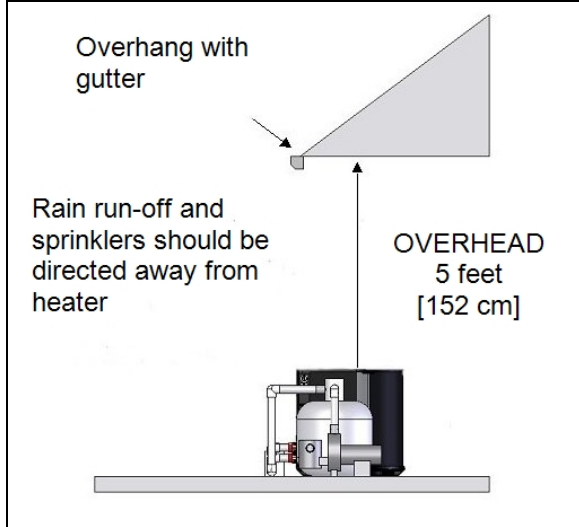

(Top View)

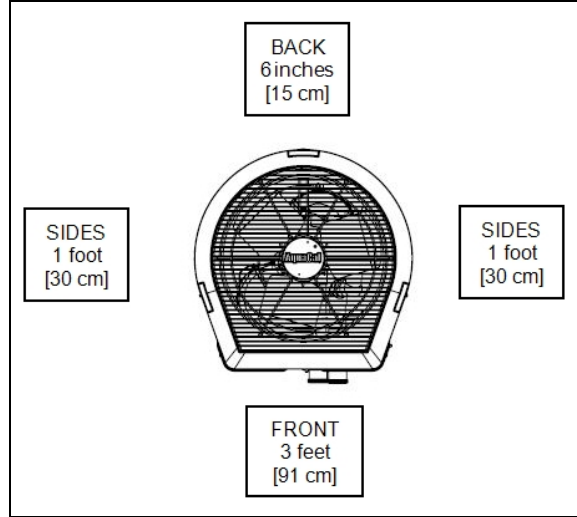

1.3 Dimensions

(HeatWave SuperQuiet® SQ120R,
SQ125, SQ145, SQ166R and SQ225)

(TropiCool® TC1500)

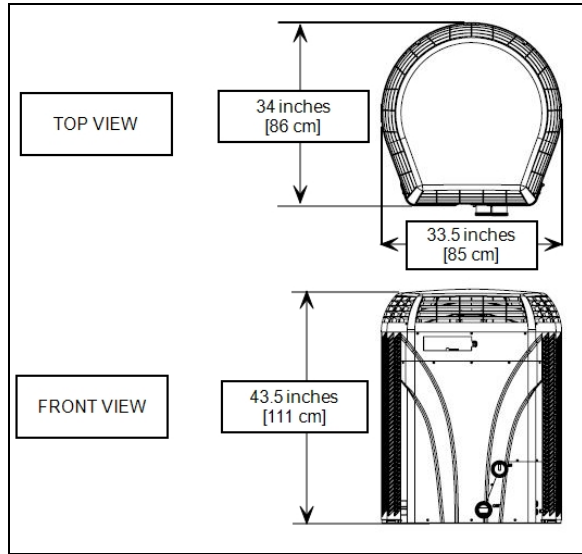

(TropiCal® T035, T055 and T075)

(TropiCool® TC500)

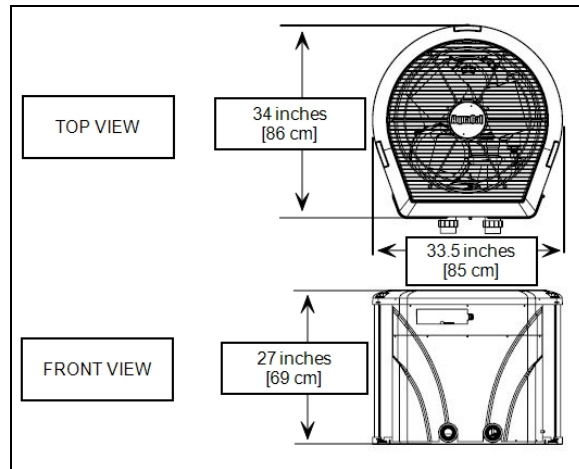

(TropiCal® T090, T115 and T135)

(TropiCool® TC1000)

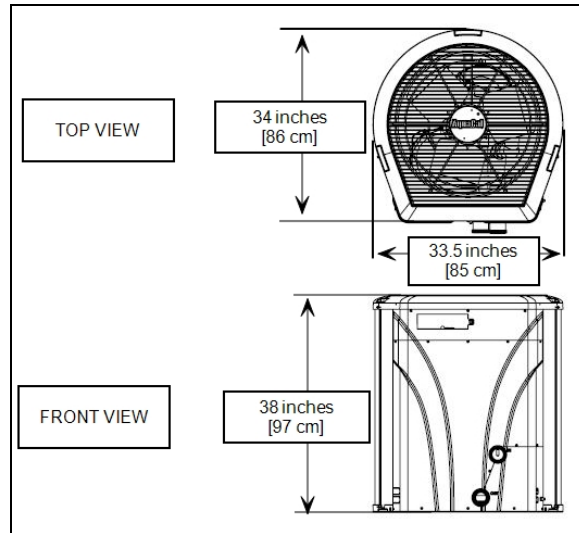

1.4 Plumbing

1.4.a Plumbing Requirements

NOTICE

Failure to heed the following may result in damage to equipment.

- Do not use glue on the threaded portion of the equipment's unions. A glued-in-place union will prevent the equipment from being properly winterized.
- The heat pump must receive water flow within the specified minimum ranges under worst-case conditions such as a fouled water filter.
- Failure to provide clean filtered water to the heat pump can void product warranty.
- Water flow exceeding maximum flow rates will negatively affect the total pool filtration performance and may damage the heat pump. This will not be covered under equipment warranty. See "Water Flow Rates" on page 11.
 - Install a bypass valve whenever water-flow may exceed maximum rating.
 - See "Bypass Valve Kit (# STK0135)" on page 70.
 - For additional guidance testing water flow rates, please contact AquaCal®.
- A safety enhancing "Over Temperature Alarm" kit is strongly recommended for all spa applications. See "Over Temperature Alarm Kit" on page 71.

1.4.b Plumbing Diagrams

Plumbing diagrams are provided in this section as a planning guide to the sequence of equipment, valves, and fittings.

- The basic plumbing configurations for typical installations are shown.
- If the installation does not closely follow any of the supplied plumbing diagrams, AquaCal® Technical Support is available for installation advice and guidance.
- Confirm water provided to heat pump is clean and filtered.

Heat Pump with water flows equal or less than maximum listed flow rate

See "Water Flow Rates" on page 11.

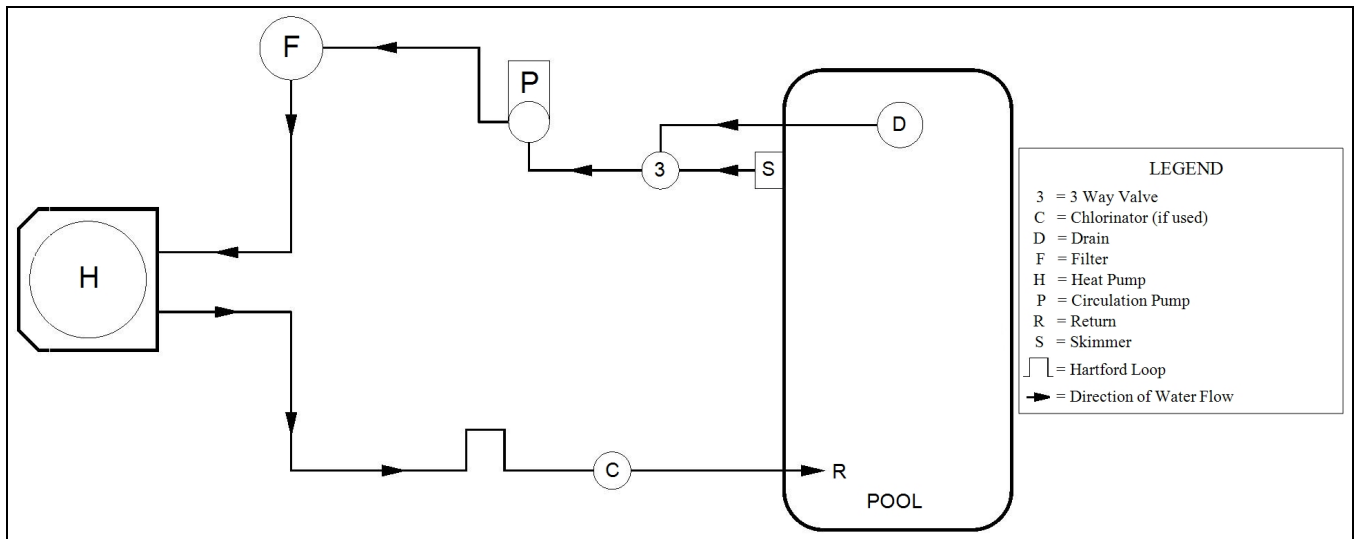

Heat Pump with water flows greater than maximum listed flow rate

See "Water Flow Rates" on page 11.

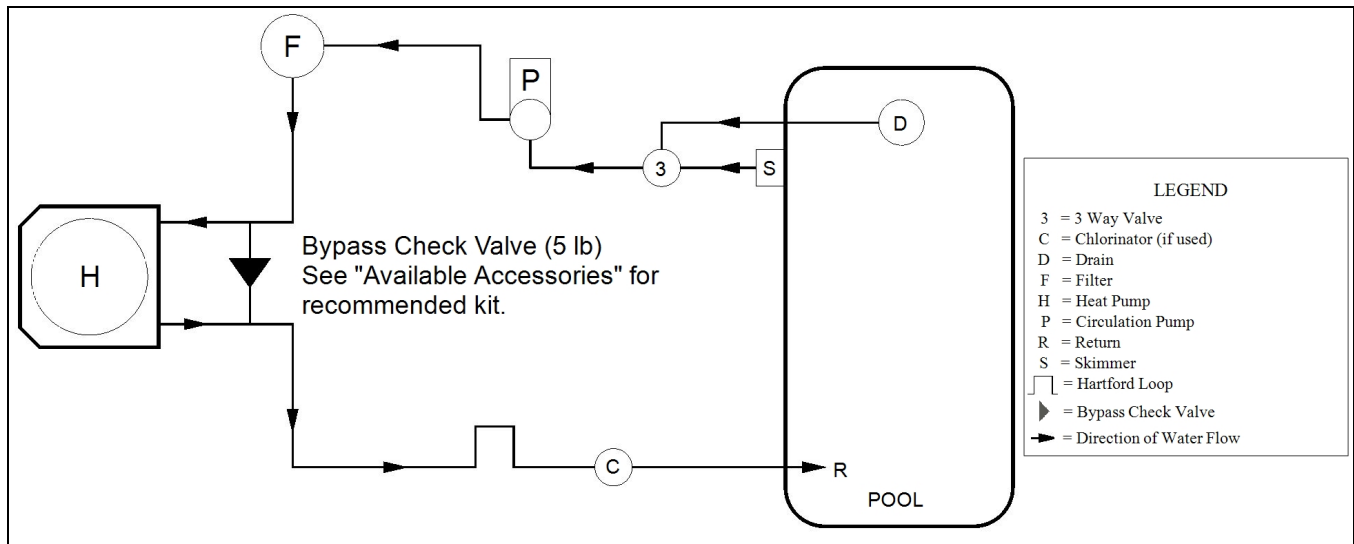

Heat Pump with Spillover Spa (One filter Pump)

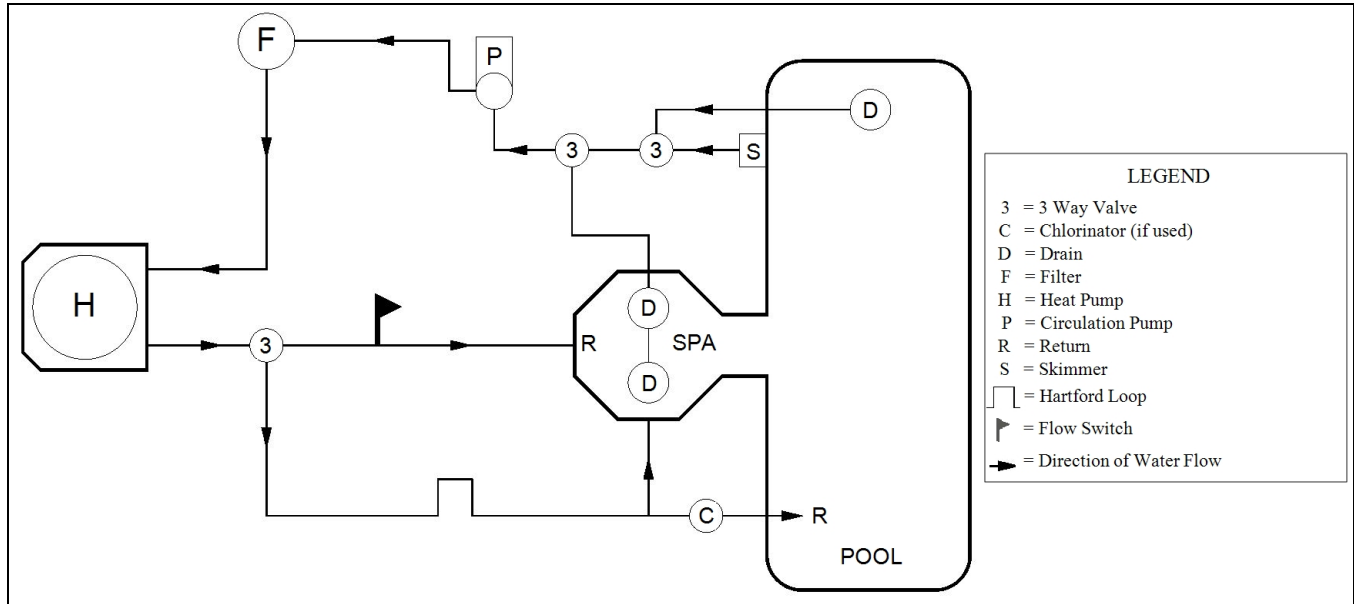

Heat Pump with Spillover Spa (Two filter Pumps)

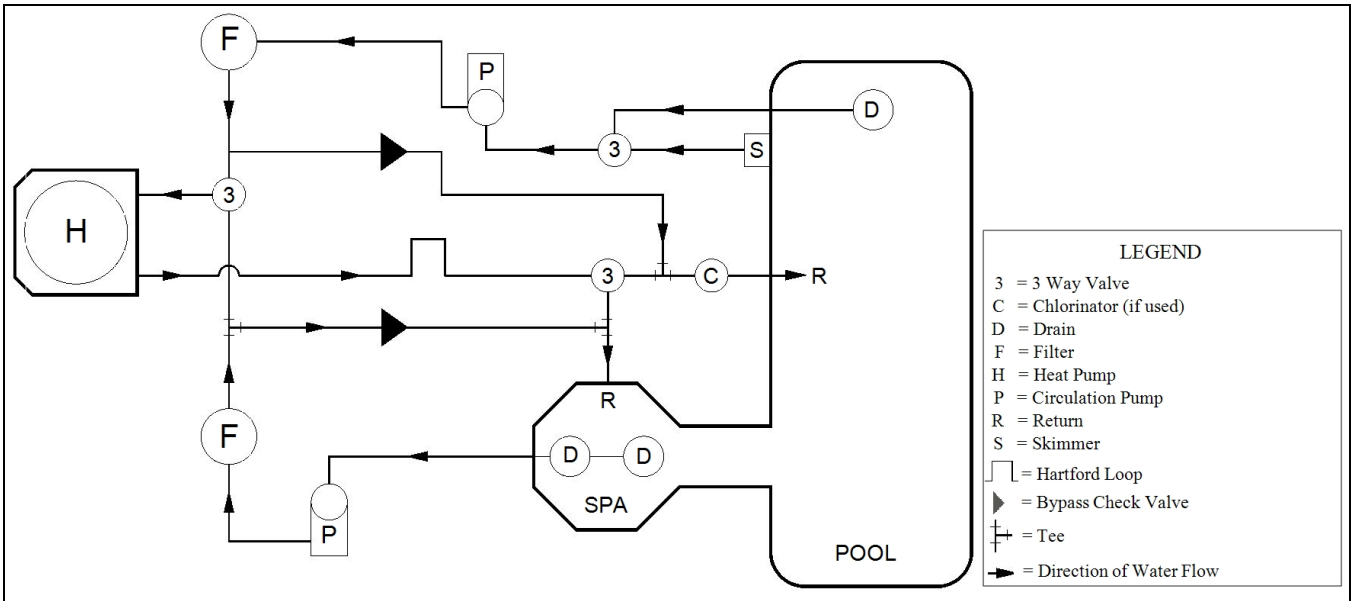

Heat Pump with Solar Panels in Plumbing Circuit

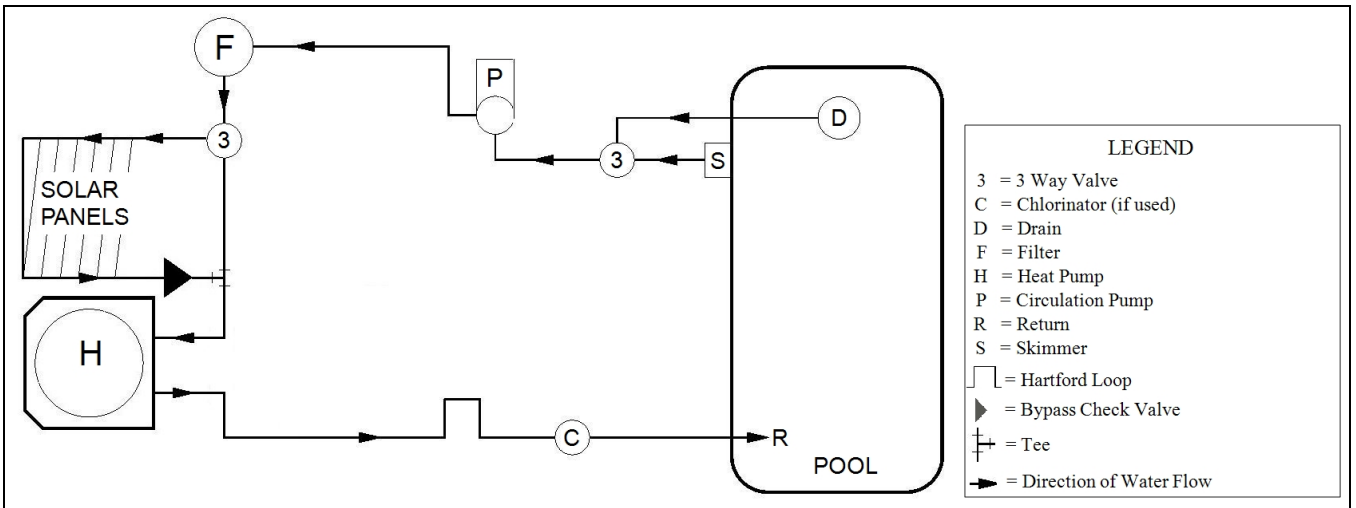

Heat Pump with Gas Heater backup

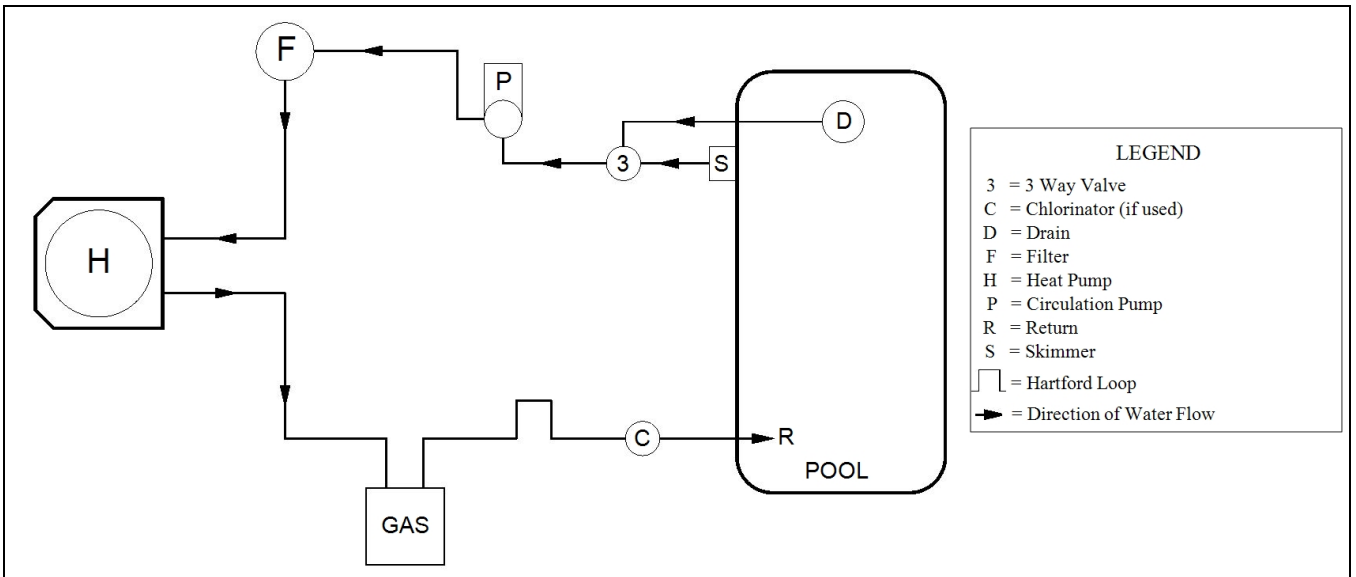

Multiple Air Source Heat Pumps

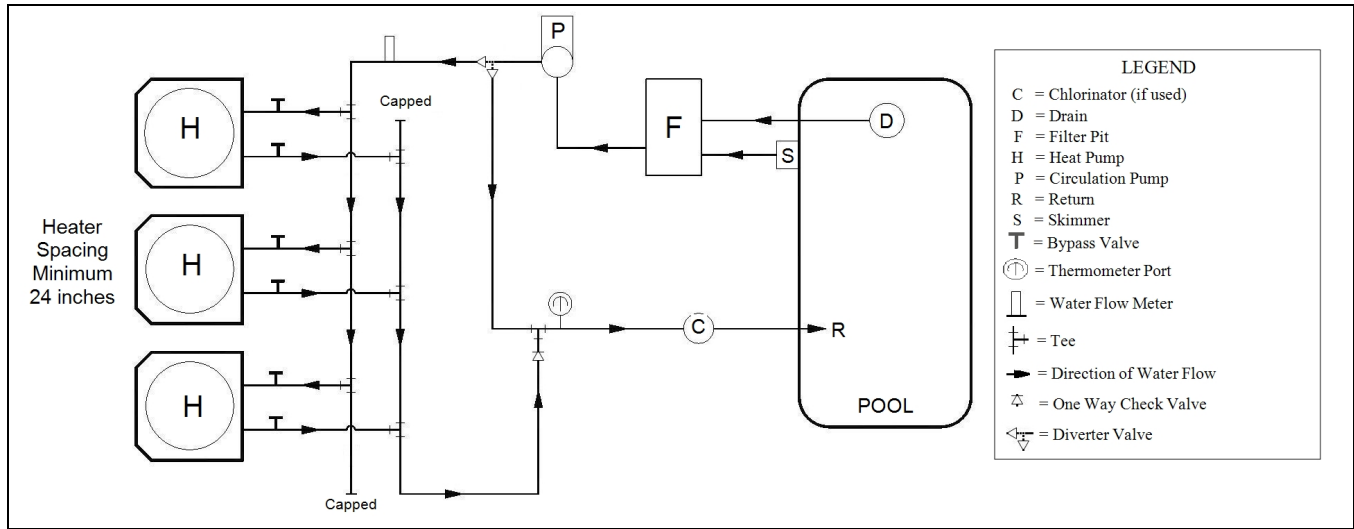

1.4.c Water Connections to Heat Pump

- Heat Pump union sizes are specified on diagrams.
- Connections to site plumbing are made via PVC solvent cement to the female slip socket of the plumbing unions.
- Plumbing unions are available from AquaCal®.

NOTICE

Failure to heed the following may result in damage to equipment.

- Do not use glue on the threaded portion of the equipment's unions. A glued-in-place union will prevent the equipment from being properly winterized.

HeatWave SuperQuiet® SQ120R, SQ125, SQ145, SQ166R, SQ225

TropiCool® TC1500

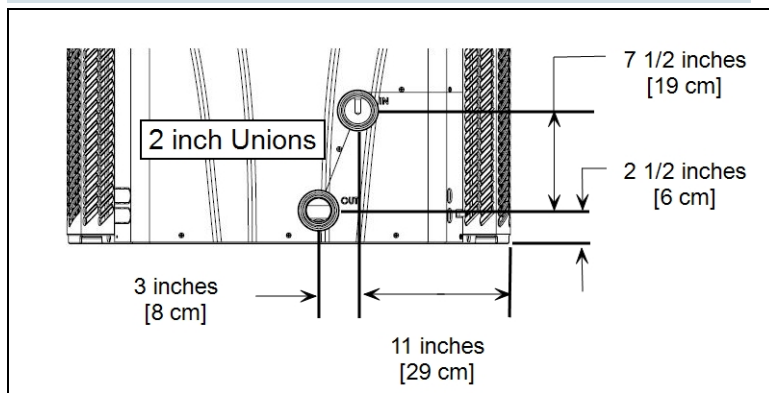

TropiCool® TC500

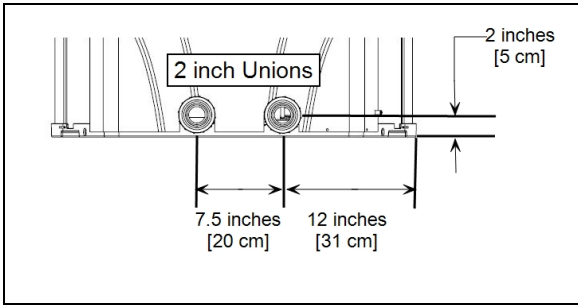

TropiCool® TC1000

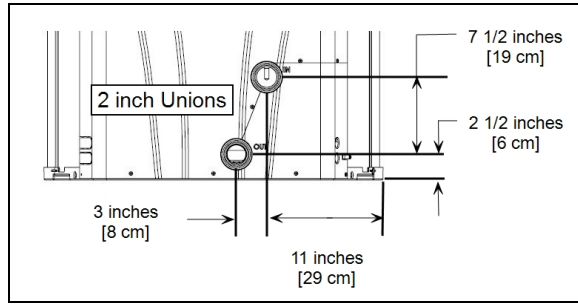

TropiCal® T035, T055, T075

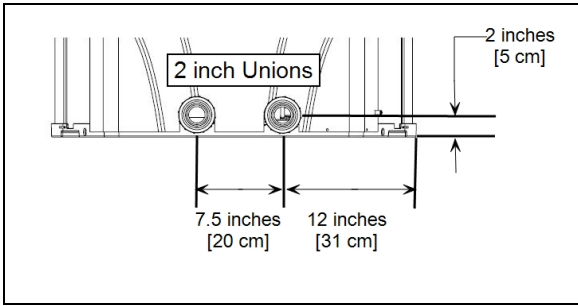

TropiCal® T090, T115, T135

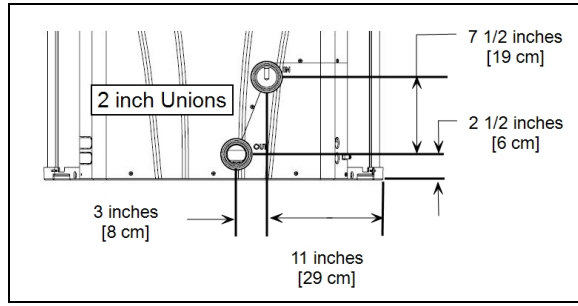

1.4.d In-Line Chlorine Feeders

Place in-line chlorinators downstream from the heat pump and as low in elevation as possible.

- If an erosion type feeder is used, it is recommended that a Hartford Loop be installed to protect internal heat pump components.
- A Hartford Loop is not necessary with a Salt Chlorine Generator.

Heat Pump with Hartford Loop

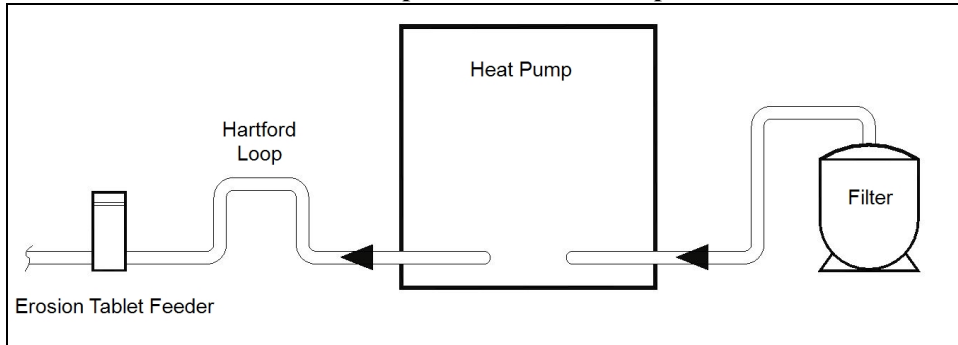

1.4.e Water Flow Rates

Maintain water flow rates as indicated. Please note, these specifications relate to the heat pump only. Code-specified whole system turnover rates must be satisfied.

NOTICE

Failure to heed the following may result in damage to equipment.

- Water flow exceeding maximum flow rates will negatively affect the total pool filtration performance and may damage the heat pump. This will not be covered under equipment warranty.

MODEL	HEAT EXCHANGER TYPE	FLOW RATES	
		MINIMUM	MAXIMUM
SQ120R	Titanium ThermoLink®	30 GPM	70 GPM
SQ125	Titanium ThermoLink®	30 GPM	70 GPM
SQ145	Titanium ThermoLink®	30 GPM	70 GPM
SQ166R	Titanium ThermoLink®	30 GPM	70 GPM
SQ225	Titanium ThermoLink®	30 GPM	70 GPM
T035	Titanium Tube-in-Tube	20 GPM	45 GPM
T055	Titanium Tube-in-Tube	20 GPM	45 GPM
T075	Titanium Tube-in-Tube	20 GPM	45 GPM
T090	Titanium ThermoLink®	30 GPM	70 GPM
T115	Titanium ThermoLink®	30 GPM	70 GPM
T135	Titanium ThermoLink®	30 GPM	70 GPM
TC500	Titanium Tube-in-Tube	20 GPM	45 GPM
TC1000	Titanium ThermoLink®	30 GPM	70 GPM
TC1500	Titanium ThermoLink®	30 GPM	70 GPM

PLEASE NOTE -

If minimum flow rates are not met, heat pump performance is reduced and performance will suffer. Internal safety devices may deactivate the heat pump with the following errors:

- **HIGH PRESSURE FAULT**
- **HP5 SYSTEM LOCKOUT**
- **LOW PRESSURE FAULT**
- **LP5 SYSTEM LOCKOUT**

- Operate water filtration devices per manufacturer's specifications. Dirty filters can cause a reduction of water flow to the heat pump. An increase of 7-10 psi higher than the clean filter pressure typically reduces flow rates. This requires the filter to be cleaned or back-washed.
- Keep baskets free of debris. A large quantity of debris in the pump and skimmer baskets can reduce water flow.
- Check for improper valve settings. A partially closed valve after the filter, or a full-open bypass around the heat pump, will cause insufficient water flow through the heat pump.
- The maximum static pressure (or operating pressure) is 50 pounds-per-square-inch (PSI). These specifications relate to the heat pump only.
- Code-specified whole system turnover rates must be satisfied.

1.4.f Adjusting Water Flow Using ΔT (Delta-T)

The Delta-T is the temperature difference between the water temperatures entering and leaving the heat pump. The equipment can be fine-tuned for maximum performance by balancing water flow rates to maintain an ideal ΔT .

The adjustment procedure must be completed with the unit in heating mode.

- Installed temperature ports are required to perform the following procedures.
- These ports are typically located on the pool in and pool out water lines approximately six inches away from the heat pump.

PLEASE NOTE -

- The installation of temperature ports are required for all commercial applications.
- The installation of temperature ports are strongly recommended for residential installations.
 - See "Temperature Port Kit (# STK0096)" on page 72.

1. Adjust thermostat to its lowest setting with unit in heating mode.
2. Deactivate the water filtration pump.
3. Confirm that the filters leading to the heat pump are clean.
4. Adjust the valves controlling water headed towards the heat pump to the half open position.
5. Adjust the valves controlling water leading away from the heat pump to a fully open position.
6. Activate the pool water filtration pump.
7. Slowly raise the thermostat temperature until the heat pump activates.
 - After a four-minute delay, the heat pump's compressor will start.
8. With the heat pump running, confirm the filtration pump is operating properly with adequate flow and no short cycling.
9. Wait for water temperatures to stabilize (approximately 5 minutes).
12. Adjust valves in the following order using the temperature chart provided.
 - a. Adjust the valve that controls water exiting the heat pump until the correct temperature differential is achieved. Match the temperature measured with a temperature probe to the chart.
 - b. Wait for water temperatures to stabilize. Then check temperature again. Re-adjust the valve as needed.
13. Mark valves at these positions for future reference.

**Temperature Port
(Shown with Probe)**

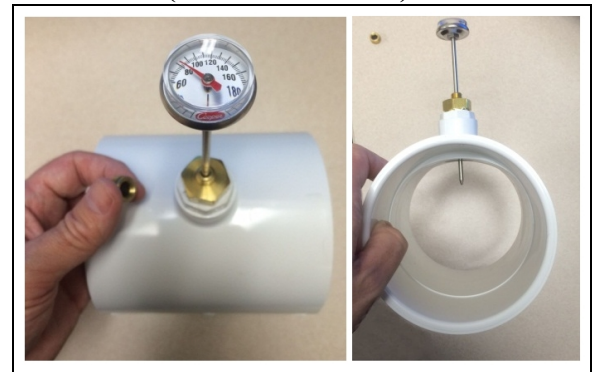

HEAT EXCHANGER TYPE	MODEL	TEMPERATURE
Titanium ThermoLink [®]	SQ120R	3° to 7° F
Titanium ThermoLink [®]	SQ125	3° to 7° F
Titanium ThermoLink [®]	SQ145	3° to 7° F
Titanium ThermoLink [®]	SQ166R	3° to 8° F

HEAT EXCHANGER TYPE	MODEL	TEMPERATURE
Titanium ThermoLink®	SQ225	4° to 9° F
Tube-in-Tube	T035	1° to 4° F
Tube-in-Tube	T055	2° to 5° F
Tube-in-Tube	T075	3° to 7° F
Titanium ThermoLink®	T090	3° to 6° F
Titanium ThermoLink®	T115	3° to 7° F
Titanium ThermoLink®	T135	4° to 8° F
Titanium Tube-in-Tube	TC500	2° to 5° F
Titanium ThermoLink®	TC1000	2° to 5° F
Titanium ThermoLink®	TC1500	3° to 7° F

Table 1 - Temperature Chart

PLEASE NOTE -

- Temperature differences are based on pool water temperatures of 69° to 75° F.
- For water temperatures outside this range, contact AquaCal®. See "Contacting AquaCal AutoPilot, Inc." on page 1.

1.4.g Maintaining Ability to Winterize

Do not glue the threaded portion of the unions. The unions are used to decouple the heat pump from the plumbing system during hard freeze conditions.

NOTICE

Failure to heed the following may result in damage to equipment.

- Do not use glue on the threaded portion of the equipment's unions. A glued-in-place union will prevent the heat pump from being properly winterized.

1.4.h Adjusting Water Pressure Switch

Adjust water pressure switch when heat pump attempts to operate without water flow.

Before attempting any adjustments confirm the following :

- The filter is clean.
- Filter pump is operating.
- The valves are set to direct the appropriate amount of water through the heat pump. See "Water Flow Rates" on page 11.
- **"NO POOL/SPA WATER FLOW"** is displayed (or displays intermittently).

WARNING

Failure to heed the following may result in injury or death.

- Water Pressure Switch adjustment procedure to be performed by experienced service personnel only; procedure must not be attempted by individuals lacking adequate electrical and mechanical experience.

NOTICE

Failure to heed the following may result in damage to equipment.

- If the heat pump continues to operate after a water pressure switch adjustment, deactivate equipment and perform additional troubleshooting.
 1. Remove heat pump access panel.
 2. Locate the water pressure switch. It will be outside and along the bottom edge of the electrical enclosure. Exact location varies by model.
 3. Activate filter pump.
 4. Apply power to heat pump.
 5. Slowly rotate the adjustment wheel on the switch. Keep turning the wheel until the heat pump indicates it is receiving water. The display will no longer indicate **"NO POOL/SPA WATER FLOW"**.
 6. Deactivate filter pump. If correctly adjusted, the heat pump will deactivate and the display will show **"NO POOL/SPA WATER FLOW"**.
 7. Re-install heat pump access panel.
 8. If the heat pump continues to operate without water flow, the installation of a grid flow switch may be required.
 - This can become necessary if the heat pump is installed below the elevation of the body of water to be heated or cooled. The standing pressure from the water can cause the water pressure switch to activate when the circulation pump is off. Therefore a water flow switch must be used in place of a water pressure switch to determine if incoming water is being sent to the heat pump. See "Grid Flow Switch (# 0040S)" on page 71.
 9. If heat pump continues to operate without water flow, contact AquaCal®.

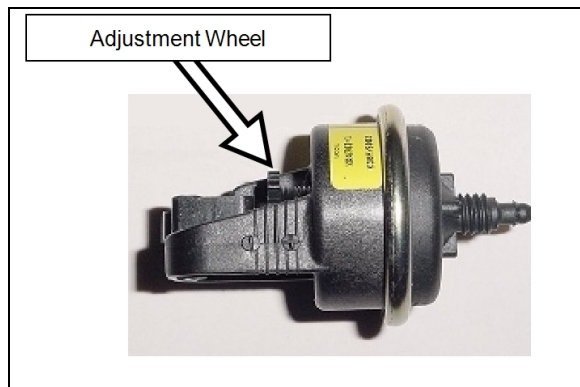

1.5 Electrical

1.5.a Electrical Requirements

WARNING

Failure to heed the following may result in injury or death.

- The information contained in this section is intended for use by qualified electricians familiar with electrical service-industry safety standards and methods.
- Locate the equipment disconnect as near to the heat pump as possible. Always satisfy applicable codes and standards.
- Never mount power-disconnects directly to the heat pump.
- In sizing power wiring, be especially aware of up-sizing requirements necessary due to wiring distances. Always satisfy applicable codes and standards.
- AquaCal® heat pumps are designed to use copper conductors, only. Do not use aluminum wire.
- If multiple heat pumps are on site, confirm that the multiple heat pump configuration has been utilized. See "Connecting Multiple Heat Pumps (Master / Slaved)" on page 36. This will prevent multiple heat pumps attempting to start at the same time, causing an excessive power drop at start-up.

Electrical Standards

Standards	Title
NFPA 70 2005	The electrical installation must conform to the current version of the National Electric Code (NEC), and all applicable local and state codes
IEC 60335-1	Household and similar electrical appliances - Safety - General Requirements
IEC 60335-2	Household and similar electrical appliances - Safety – Particular requirements for electrical heat pumps, air-conditioners, and dehumidifiers
UL 1995 & CSA C22.2 No. 236-15	Standard for Safety - Heating and cooling equipment

Table 2 - Standards

Grounding and Bonding

Follow local code requirements for properly grounding and bonding heat pump equipment.

- A bonding lug has been provided on the lower right hand corner of the front access panel.

Surge Suppression

The use of approved commercial surge protectors is strongly recommended.

Sizing the Electrical Service

Refer to equipment data plate for specific information required to size electrical service and over-current protection of heat pump. Sizing is based on data plate information, wire size, wiring devices, and over-current protection per applicable local codes and standards. See "Identifying Model Specifications" on page 68.

Minimum and Maximum Operating Voltage

The heat pump must operate within specified voltages.

NOTICE

Failure to heed the following may result in damage to equipment.

- Operating equipment under higher or lower voltage conditions may result in damage to your compressor, motors or other electrical components. This damage will not be covered by product warranty.
1. Measure site voltage. The site voltage **MUST** be measured under “FULL LOAD” conditions. Activate all equipment using the same electrical panel as the heat pump.
 2. If measured site voltage is outside listed ranges, immediately deactivate equipment until site conditions have been corrected. If unsure of heat pump equipment rating, please see "Identifying Model Specifications" on page 68.

Equipment Rating	Minimum Site Voltage	Maximum Site Voltage
A Voltage (208 to 230 Volts) Single Phase 60 hertz	200 Volts	253 Volts
B Voltage (208 to 230 Volts) Three Phase 60 hertz	200 Volts	253 Volts
D Voltage (380 to 420 Volts) Three Phase 50 hertz	361 Volts	441 Volts
E Voltage (380 Volts) Three Phase 60 hertz	361 Volts	399 Volts
G Voltage (460 Volts) Three Phase 60 hertz	437 Volts	483 Volts
H Voltage (200 to 240 Volts) Single Phase 50 hertz	180 Volts	264 Volts

1.5.b Incoming Power Access Holes

(HeatWave SuperQuiet®
SQ120R, SQ125, SQ145,
SQ166R and SQ225)
(TropiCool® TC1500)

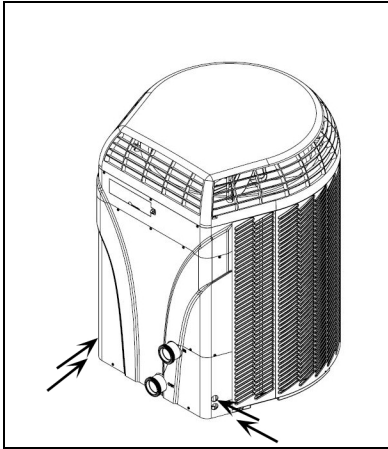

(TropiCal® T035, T055
and T075)
(TropiCool® TC500)

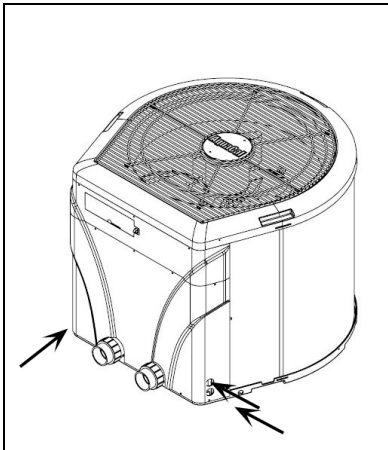

(TropiCal® T090, T115
and T135)
(TropiCool® TC1000)

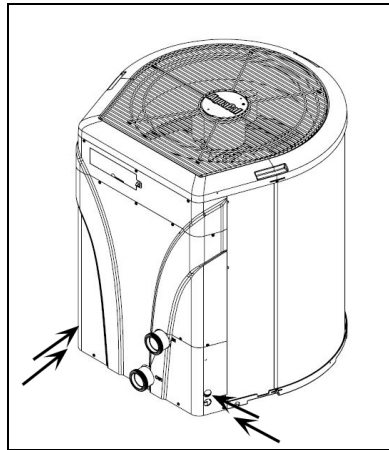

1.5.c Access Panels

HeatWave SuperQuiet®

TropiCool® TC1500

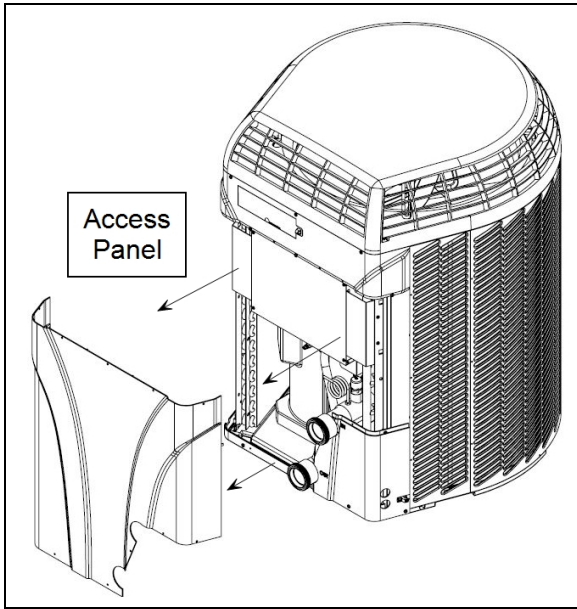

TropiCal® T035, T055 and T075

TropiCool® TC1000

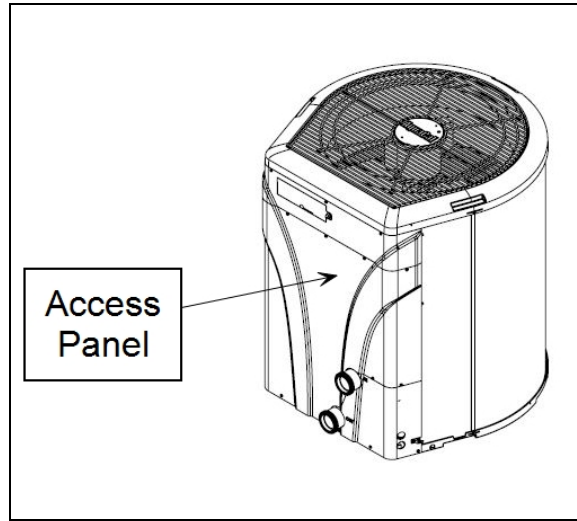

TropiCool® TC500

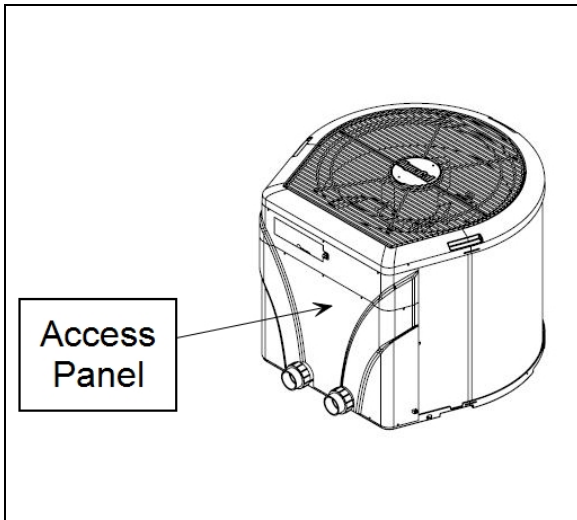

1.5.d Verifying Transformer Setting

Transformer voltage must be confirmed and set correctly depending on the measured voltage found on the site. Incorrect settings may cause heat pump damage. The following procedure will allow the installer to set the heat pump's transformer for the appropriate site voltage.

⚠ WARNING

Failure to heed the following may result in injury or death.

- The information contained in this section is intended for use by qualified technicians, familiar with electrical service-industry safety standards and methods.

1. Turn heat pump on by adjusting the thermostat to call for heating or cooling. If more than one heat pump is on site, turn them all on. Allow time for all heat pump compressors to activate.
2. Measure the running site voltage.
3. Confirm transformer tap is set for the measured site voltage. If more than one voltage tap is shown, select the voltage nearest to the running site voltage.

**Example of heat pump transformer
(Varies between models)**

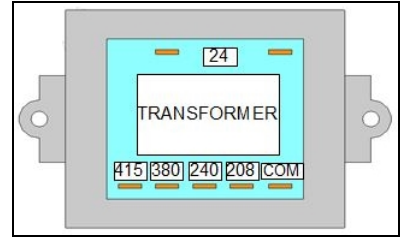

PLEASE NOTE -

- If more than one voltage is shown on the equipment's data plate, the factory default setting is usually the higher voltage on the transformer.
- As an example, a "208/230" voltage will be set to "240" from the factory.

1.5.e Three-Phase Adjustment



Failure to heed the following may result in injury or death.

- The information contained in this section is intended for use by qualified technicians, familiar with electrical service-industry safety standards and methods.

If a three-phase unit fails to operate at start up, the orientation of the line voltage "field" wiring may need to be adjusted.

- The phase monitor is located inside the electrical panel.
1. Deactivate power to the unit. **Confirm that power is off to all three legs using an electrical test meter set for the correct voltage.**
 2. Switch position of the incoming power wires at each leg as follows, re-connect power, and attempt to restart the unit. If the unit fails to start, disconnect power. Verify off and proceed to next leg.
 - Switch incoming power wires at L1 and L2 on the line side to the contactor.
 - Switch incoming power wires at L1 and L3 on the line side to the contactor.
 - Switch incoming power wires at L2 and L3 on the line side to the contactor.
 3. When heat pump starts, disconnect power and verify off. Then confirm all line voltage connections are securely tightened. Reconnect power.
 - If heat pump does not start, contact AquaCal® for further assistance. See "Contacting AquaCal AutoPilot, Inc." on page 1.

Three-Phase Monitor



1.5.f Schematic Location

Schematics are located on the inside of the electrical panel.

1.6 External Equipment

1.6.a Connecting a Call Flex

To support a direct connection to a call flex accessory, AquaCal® heat pumps are equipped with optional terminal blocks on the microprocessor. The microprocessor is located on the low-voltage side of the electrical enclosure.

The call flex accessory can override a circulation pump to provide water flow to the heat pump when the set temperature is not met. For ordering information on the accessory, see "Call Flex Accessory (# 0030-LEDS)" on page 70.

Connecting a Call Flex



DANGER

Failure to heed the following will result in injury or death.

- Deactivate power while routing wiring to control board.



WARNING

Failure to heed the following may result in injury or death.

- This section is only for qualified installers who are familiar with swimming pool and spa safety standards.
- The installer must be familiar with service industry techniques.

NOTICE

Failure to heed the following may result in damage to equipment.

- The wire size connecting the controller must be 22-gauge (minimum), 2-conductor, low-voltage wire.
 1. Deactivate power to heat pump.
 2. Remove heat pump electrical access panel.
 3. Route 22-gauge (minimum), 2-conductor, low-voltage wires to the low voltage side of the electrical enclosure. Follow all National Electric Codes (NEC) unless State or Local guidelines supersede.
 4. Connect the controller wires to the port labeled "Call Flex" on the microprocessor as indicated.
 5. Reattach heat pump access panel.
 6. Apply power to heat pump.
 7. Configure heat pump to indicate an installed Call Flex.

Connection Points to the Microprocessor

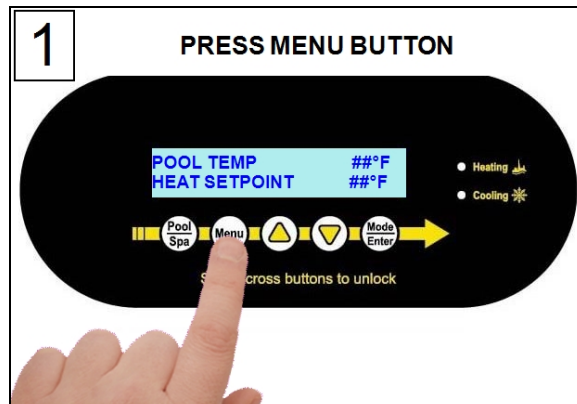
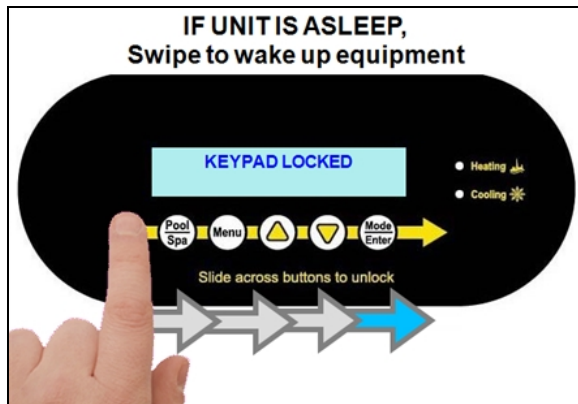
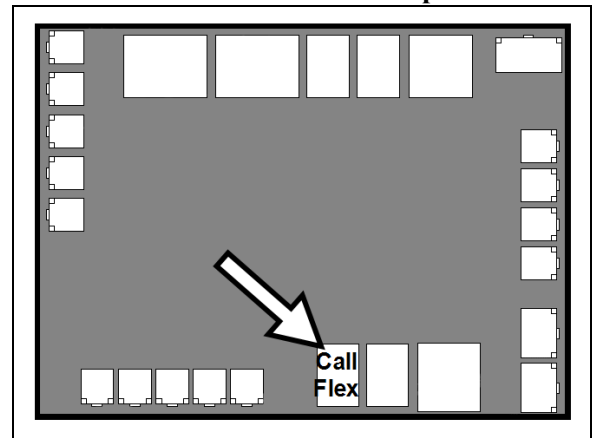

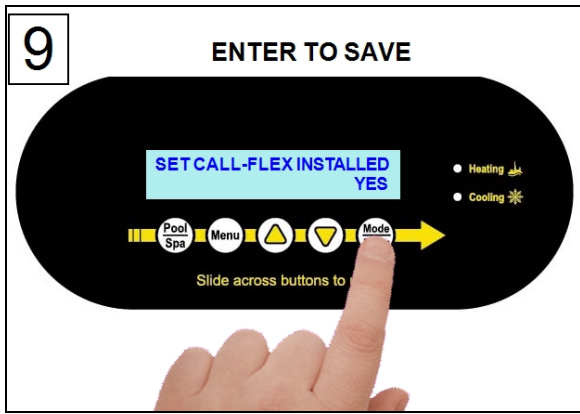
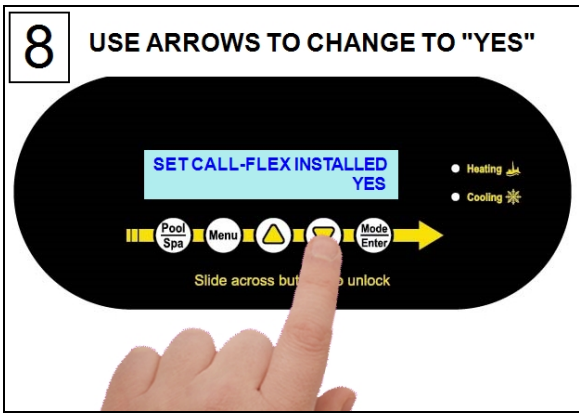
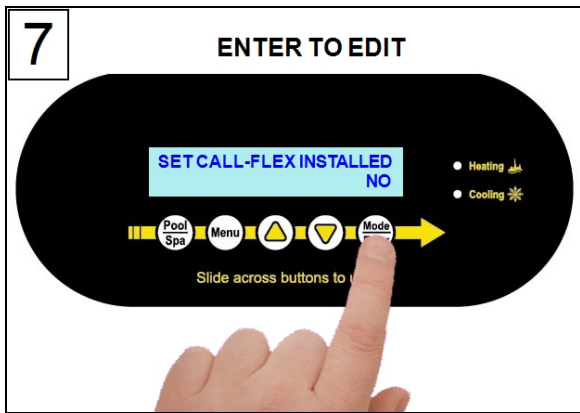
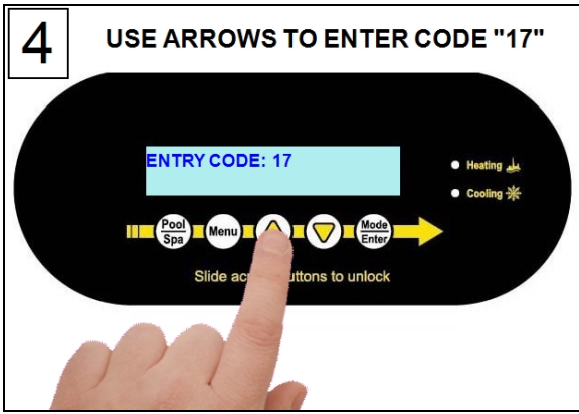
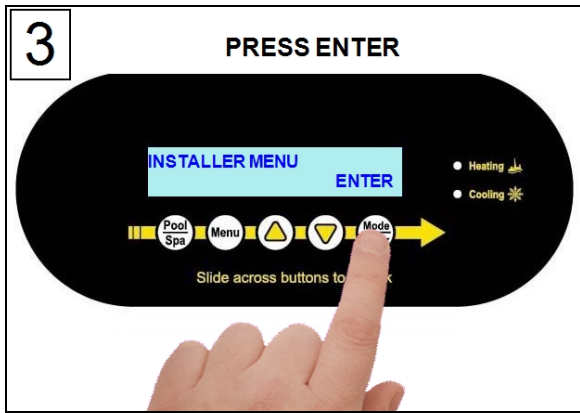
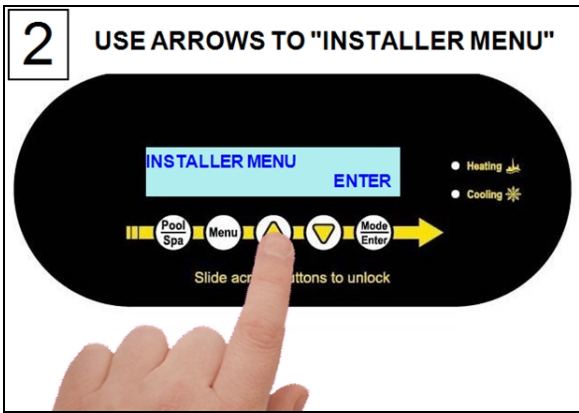

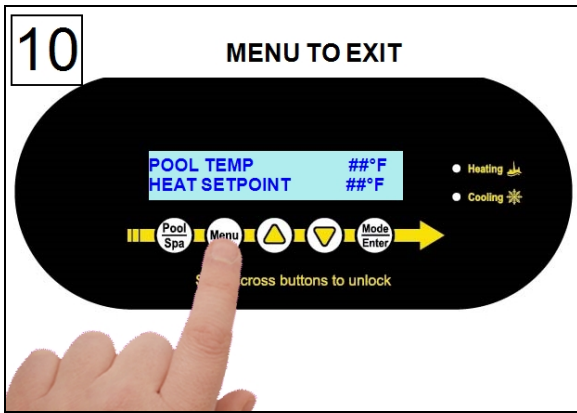

1.6.b Connecting External Controllers to Heat Pump

To support a direct connection to an external controller, AquaCal® heat pumps are equipped with optional removable terminal blocks on the microprocessor. The microprocessor is located on the low-voltage side of the electrical enclosure.

b.1 Connecting Smart Bus Controllers



DANGER

Failure to heed the following will result in injury or death.

- Risk of Electric Shock. Deactivate power while routing wiring to control board.
- Follow all National Electric Codes (NEC) and / or State and Local guidelines.



WARNING

Failure to heed the following may result in injury or death.

- This section is only for qualified installers who are familiar with swimming pool and spa safety standards.
- The installer must be familiar with service industry techniques.

NOTICE

Failure to heed the following may result in damage to equipment.

- **Do not use electric heater connection on external controllers for heat pump wiring.** This can cause damage to external controller, heat pump, and pad equipment. This damage is NOT covered by warranty.
- The wire size connecting the external controller to the heat pump must be 22-gauge, 2-conductor, low-voltage wire.
- Use the two middle data lines on the external controller's standard communication port (RS-485). Do not use the outside power or ground connection on the port.

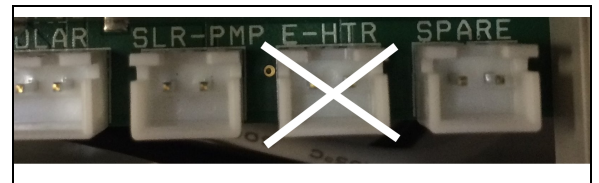

Wire Connections

1. Deactivate power to heat pump and external controller.
2. Remove electrical access panels on heat pump and external controller.
3. Route 22-gauge, 2-conductor, low-voltage wires from the external controller communication port (com port) to the low voltage side of the heat pump's electrical enclosure. Do not use the power or ground wire.

Standard External Controller Communication Port

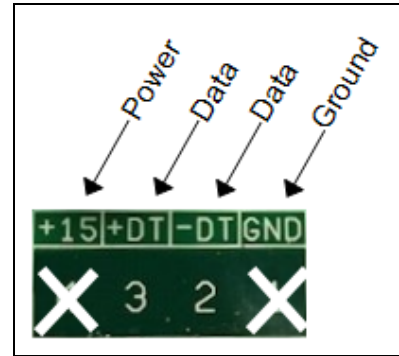

Typically a smart bus controller will have four wires on its smart bus for a heat pump. The power and ground (usually the 1st and 4th wire) are not used.

4. Connect control wires to the heat pump's "Port B" of the microprocessor as indicated. See Figure 1 and Figure 2. It is OK to double up wires at the external controller connection if necessary. If, for example the external controller is using the data port for an indoor controller, add wires to existing configuration. *Connectors can be removed from terminals for ease in connecting wires. See Figure 3*

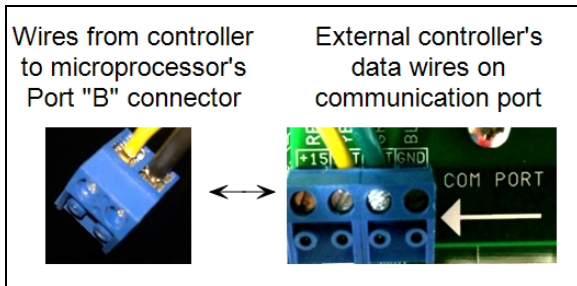

Figure 1

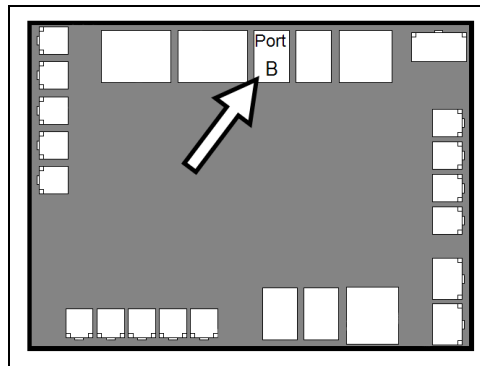

Figure 2

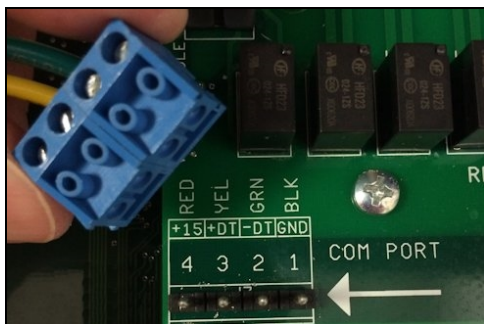

Figure 3

5. If dip-switch settings are required, configure them on the external controller now.



Failure to heed the following will result in injury or death.

- Deactivate power to external controller while setting dip-switches

Jandy AquaLink® Example:

This external controller has dip switches. Confirm they are properly positioned to operate a heat pump.

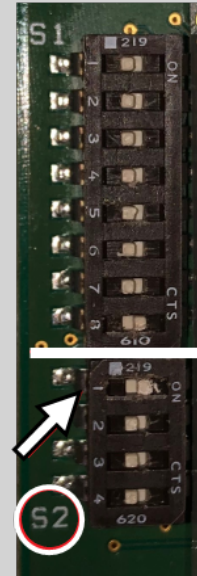

- Set dip-switch "S2" #1 to "ON". The solar option is to be used for the heat pump.
- Check Jandy documentation for any further dip switch settings.

6. If additional sensors are required on the external controller, install them on the external controller now.

Pentair EasyTouch® and Pentair IntelliTouch® Example:

Some controllers require an additional sensor be connected to the external controller's power supply circuit board at the solar connection point. The sensor is not used, but will show an error if not connected.



7. Reinstall electrical access panels on both heat pump and external controller.
8. Reactivate power to heat pump and external controller.
9. Configure heat pump to accept external controller signal.

Configure for Smart Bus Controller

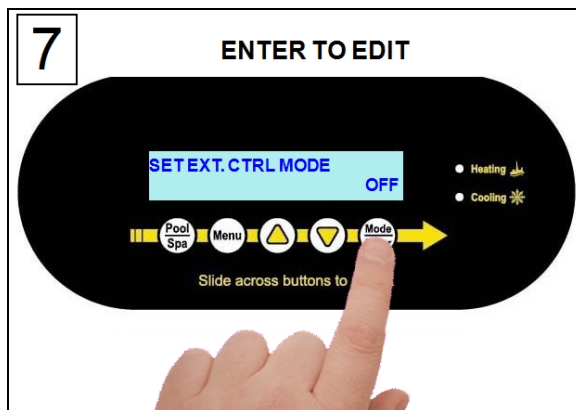
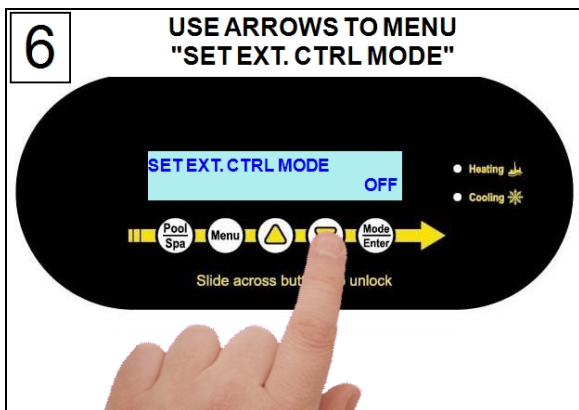
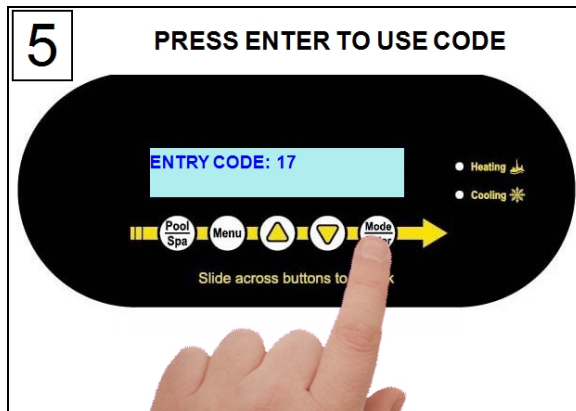
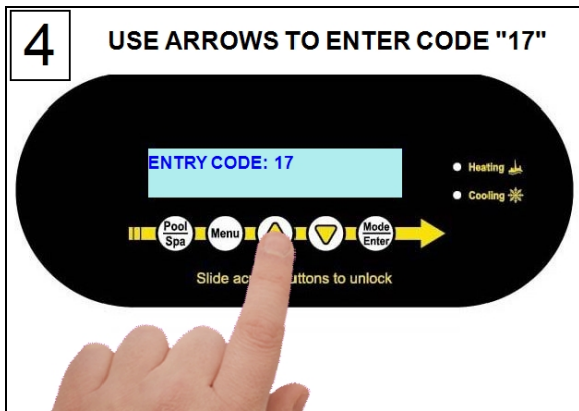
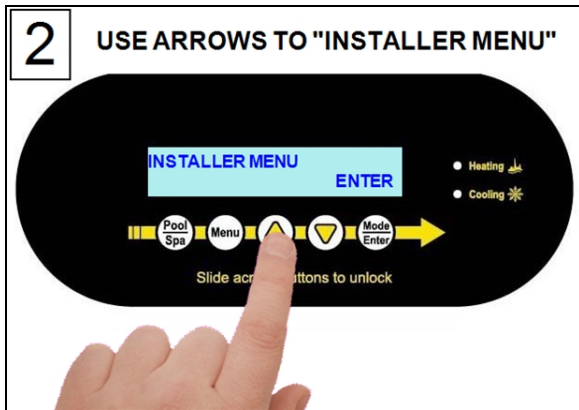
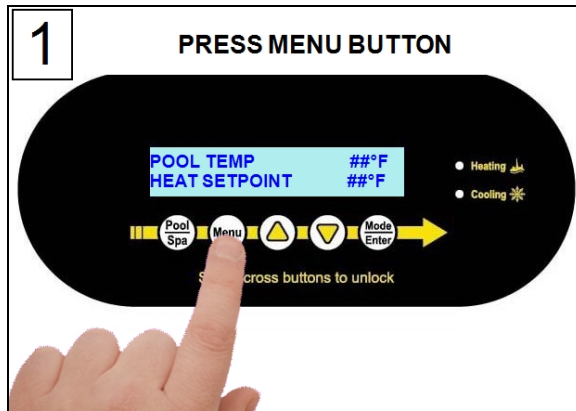
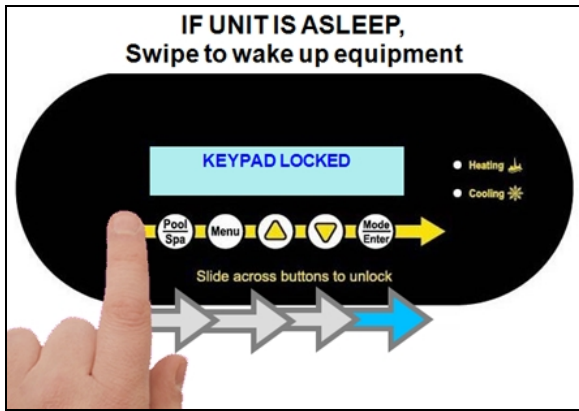

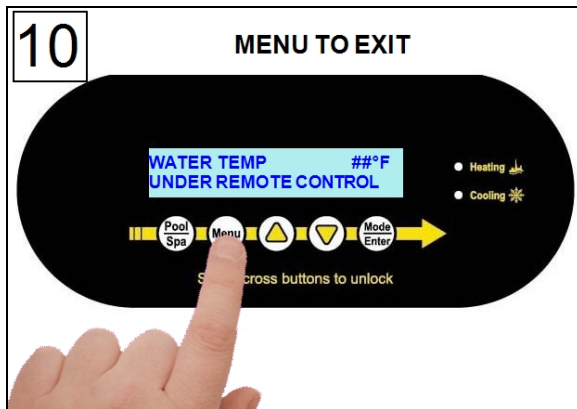
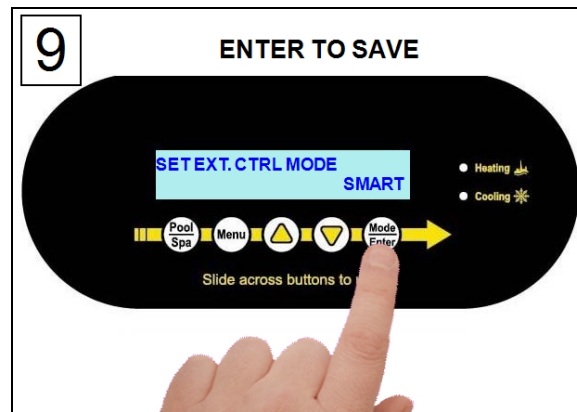
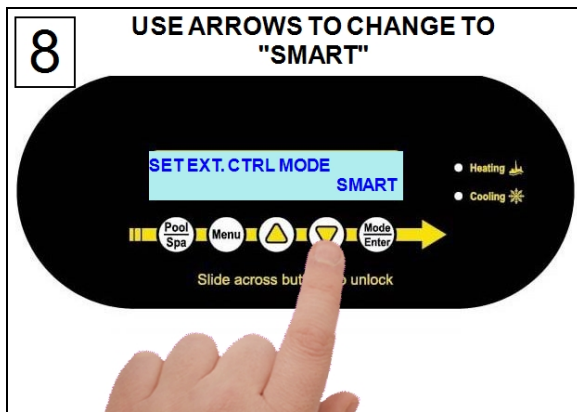

10. If after 45 seconds, the heat pump displays a "**SMART COMM FAULT**":
- A. **Confirm dip switches** - If external controller uses dip switches, confirm switches are in the correct position. Otherwise proceed to confirm wiring.
 - a. Deactivate power to external controller.
 - b. Remove access panel on external controller.
 - c. Check external controller manual for proper dip switch positioning and confirm dip switches.
 - d. Reinstall electrical access panel.
 - e. Reactivate power to the controller.
 - f. If fault persists, proceed to confirming wiring.
 - B. **Confirm wiring** - Confirm wires are oriented properly on the heat pump's "Port B" of the microprocessor.
 - a. Deactivate power to heat pump and external controller.
 - b. Remove access panel on heat pump.
 - c. Reverse wires on "Port B".
 - d. Reinstall electrical access panel.
 7. Reactivate power to the controller.
 8. Reactivate power to the heat pump.
 - C. If fault continues to occur, check with manufacturer of external controller for additional advice on using a heat pump with the controller.
11. After establishing a connection from the external controller to the heat pump, further programming will be required at the external controller.
- See external controller manuals or contact installer or manufacturer of that product.

b.2 Connecting Two-wire Controllers (with internal thermostat)

PLEASE NOTE

2-Wire controllers are not designed to control chiller operation.

For full functionality, the Heat and Cool, and Cool Only heat pumps must use an external controller that has a SMART bus connection. Check with external controller manufacturer for more information.

⚠ DANGER

Failure to heed the following will result in injury or death.

- Risk of Electric Shock. Deactivate power while routing wiring to control board.
- Follow all National Electric Codes (NEC) and / or State and Local guidelines.

⚠ WARNING

Failure to heed the following may result in injury or death.

- This section is only for qualified installers who are familiar with swimming pool and spa safety standards.
- The installer must be familiar with service industry techniques.

1. Deactivate power to heat pump.
2. Remove heat pump electrical access panel.
3. Route 22-gauge (minimum), 2-conductor, low-voltage wires from the controller to the low voltage side of the heat pump's electrical enclosure. Follow all National Electric Codes (NEC) unless State or Local guidelines supersede.
4. Connect the controller wires to the microprocessor port labeled "Ext Controller" with the terminals labeled "Y" and "Z" as follows. See Figure 4.
 - Connect one wire to "Y".
 - Connect other wire to "Z".
 - The polarity of the wire is not important.
5. Reattach heat pump access panel.
6. Apply power to heat pump.
7. Configure heat pump to accept a 2-wire external controller signal as shown.

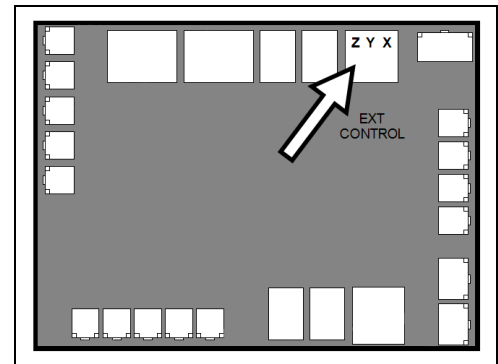
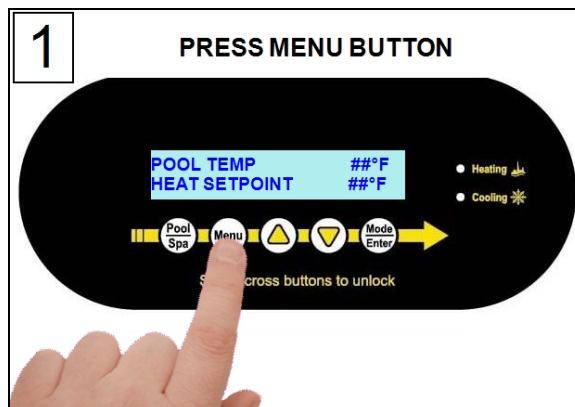
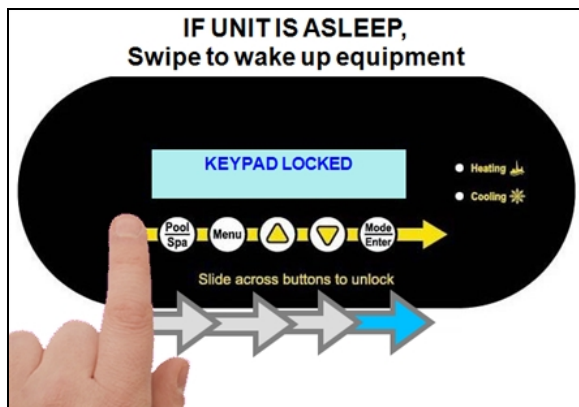
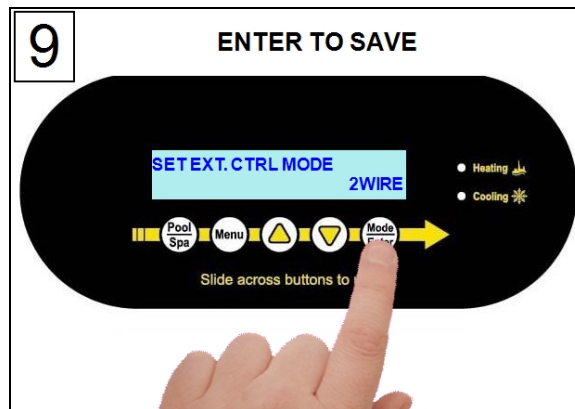
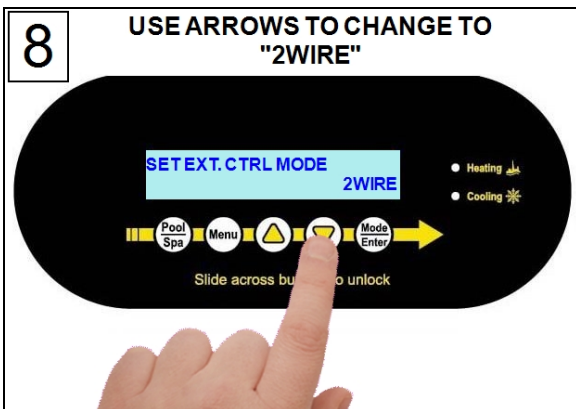
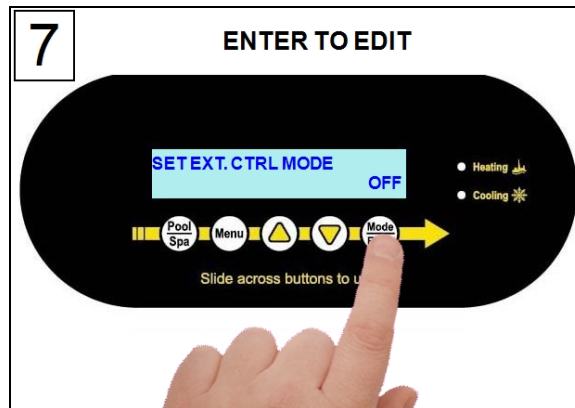
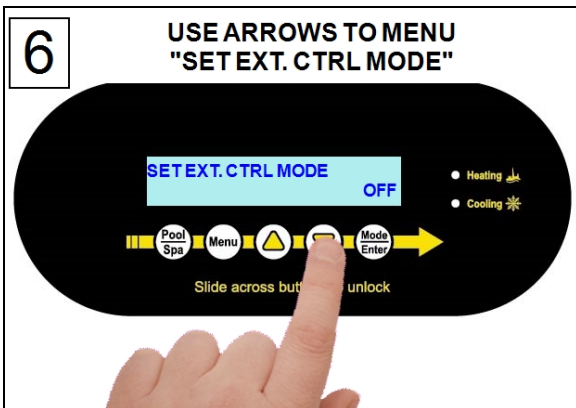
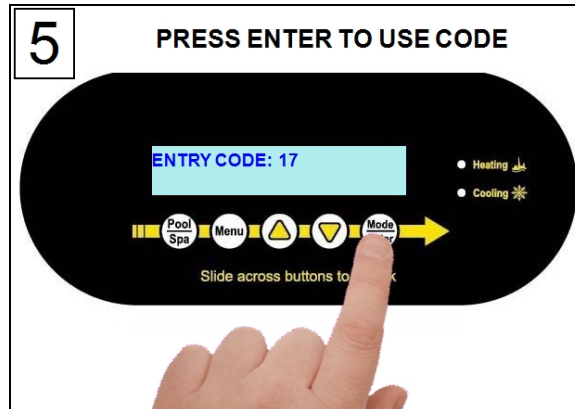
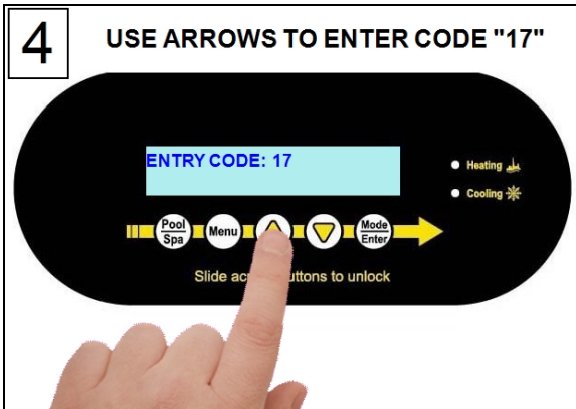
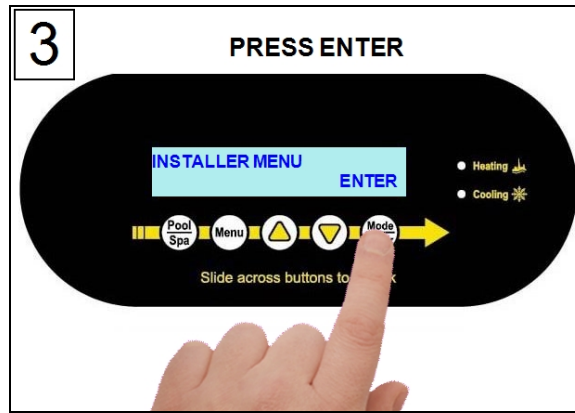
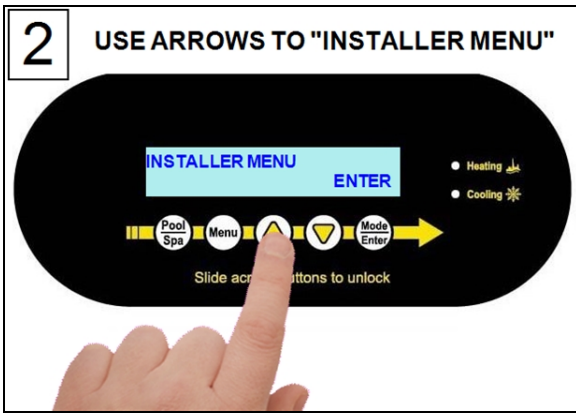
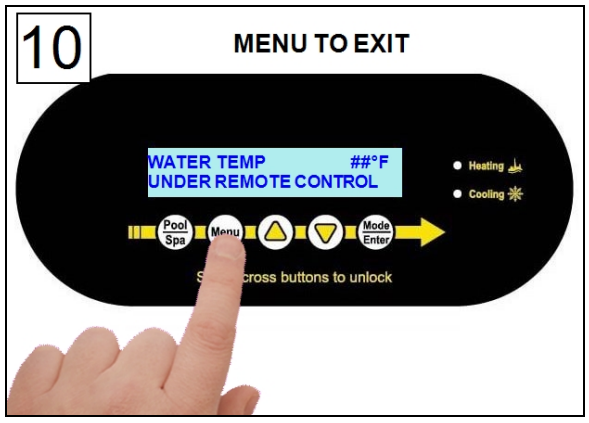

Figure 4







1.6.c Connecting Gas Backup Heater to Heat Pump

To support a direct connection to a gas backup heater, AquaCal® heat pumps are equipped with optional terminal blocks on the microprocessor. The microprocessor is located on the low-voltage side of the electrical enclosure.

PLEASE NOTE -
If the heat pump is connected and using an external controller with a SMART bus connection, the gas backup option is not available. The gas backup should be connected directly to the external controller.

⚠ DANGER

Failure to heed the following will result in injury or death.

- Deactivate power while routing wiring to control board.

⚠ WARNING

Failure to heed the following may result in injury or death.

- This section is only for qualified installers who are familiar with swimming pool and spa safety standards.
- The installer must be familiar with service industry techniques.

NOTICE

Failure to heed the following may result in damage to equipment.

- The wire size connecting the gas heater to the heat pump must be 22-gauge (minimum), 2-conductor, low-voltage wire.
- Use direct connection (**dry contact**) provided on the microprocessor for gas heater.
- Failure to follow the manufacturers installation requirements for a fireman (cool down) switch may result in damage to the gas heater.

Connections

1. Deactivate power to heat pump and gas heater.
2. Remove heat pump and gas heater's electrical access panels. Follow all National Electric Codes (NEC) unless State or Local guidelines supersede.
3. Route 22-gauge (minimum), 2-conductor, low-voltage wires from the gas heater to the low voltage side of the heat pump's electrical enclosure. Depending on the gas heater's circuit boards, use the following connection points from the gas heater.
 - Use the "Com" and "Pool" connection points from the gas heater. See Figure 5.
 - Or replace the jumper wire from the Fireman's Switch on the gas heater with two wires leading to the heat pump. See Figure 6.

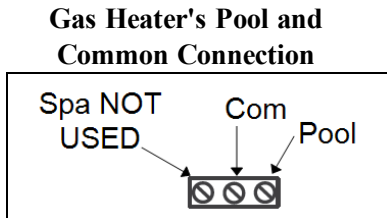

Figure 5

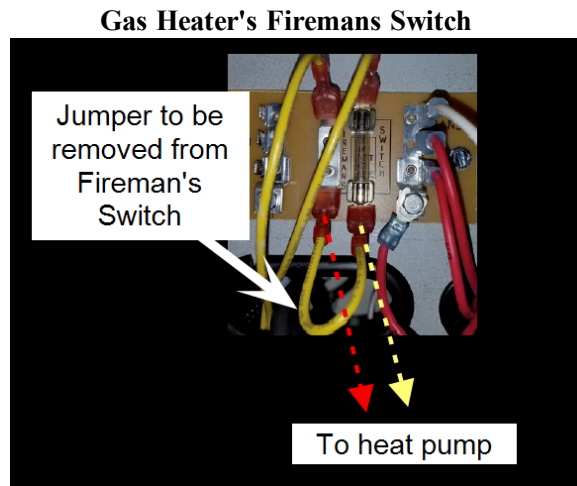

Figure 6

If the Gas Heater requires a fireman's (cool down) switch, it is the installers responsibility to ensure this requirement is met. Failure to follow the manufacturers installation requirements may result in damage to the gas heater.

PLEASE NOTE

Do not use a smart connection data comm port from the gas heater.

5. Connect the controller wires to the port labeled "Gas" on the microprocessor as indicated.
6. Reattach heat pump and gas heater access panels.
7. Apply power to heat pump and gas heater.
8. Configure gas heater to accept a two-wire remote control signal. See gas heater's manual for specifics on this procedure.
9. Configure gas backup mode on heat pump (See "Configuring Gas Backup" in this section.).

Dry Contact Connection Points to the Microprocessor

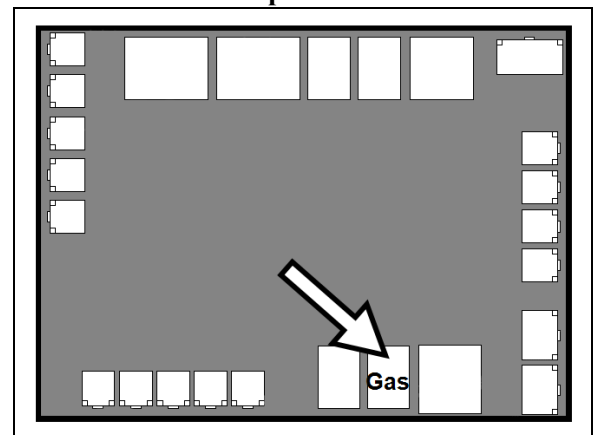

Configuring Gas Backup

There are two different ways the gas backup heater can be configured.

Under no circumstances should the gas heater be allowed to operate with a longer time frame than the circulation pump schedule.

- **24 hour mode** - commonly used for commercial applications
 - The circulation pump operates continuously and is not controlled by a time clock or external control device.
 - The gas heater will activate if the water temperature falls two degrees below set temperature. When set temperature is reached, the gas heater will be deactivated. See "Configure for 24 Hour Mode Gas Backup" on page 32.
 - The Heat Pump will continue to maintain the set temperature.
- **Scheduled mode** - commonly used for residential applications
 - The circulation pump operates on a regular schedule on - off schedule.
 - The gas heater will activate as needed to ensure that the desired temperature will be reached within the circulation pumps schedule. The gas heater will deactivate when the water is warm enough to allow the heat pump to finish within schedule. The heat pump will then continue to heat the water till set temperature is reached. See "Configure for Scheduled Mode Gas Backup" on page 34.

Configure for 24 Hour Mode Gas Backup

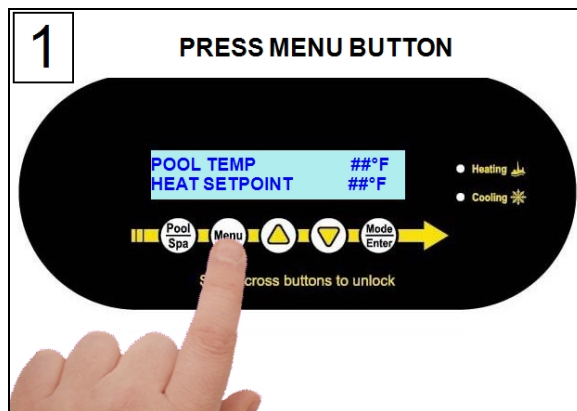
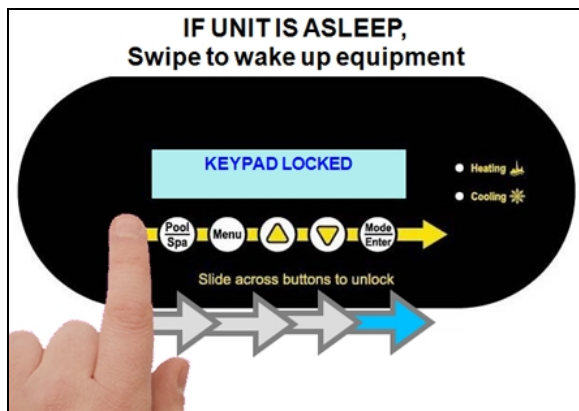

4 USE ARROWS TO ENTER CODE "17"

Slide across buttons to unlock

5 PRESS ENTER TO USE CODE

Slide across buttons to unlock

6 USE ARROWS TO "BACKUP HEAT MODE"

Slide across buttons to unlock

7 ENTER TO EDIT

Slide across buttons to unlock

8 USE ARROWS TO CHANGE TO "24HR"

Slide across buttons to unlock

9 ENTER TO SAVE

Slide across buttons to unlock

10 MENU TO EXIT

Slide across buttons to unlock

Configure for Scheduled Mode Gas Backup

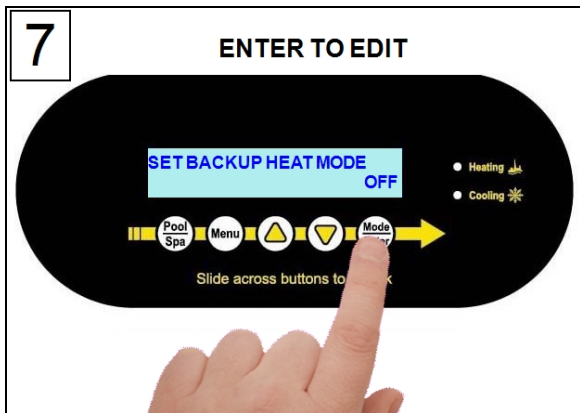
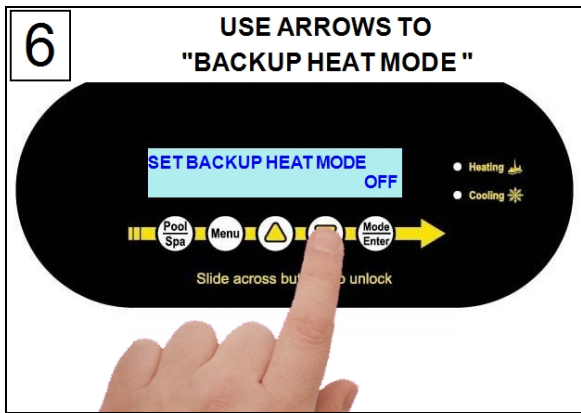
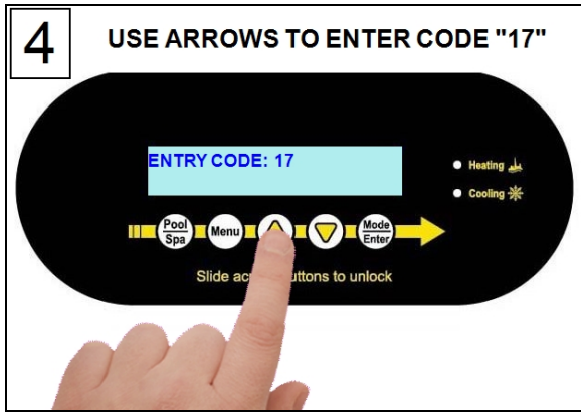
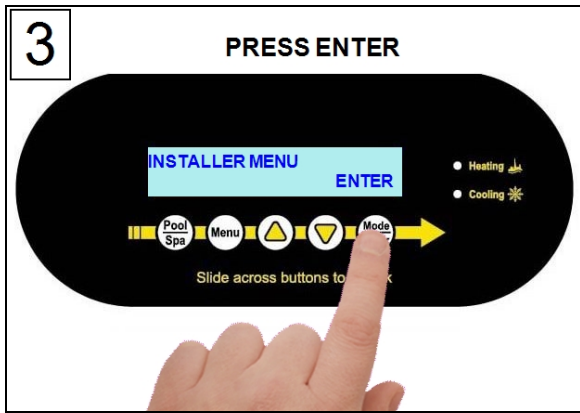
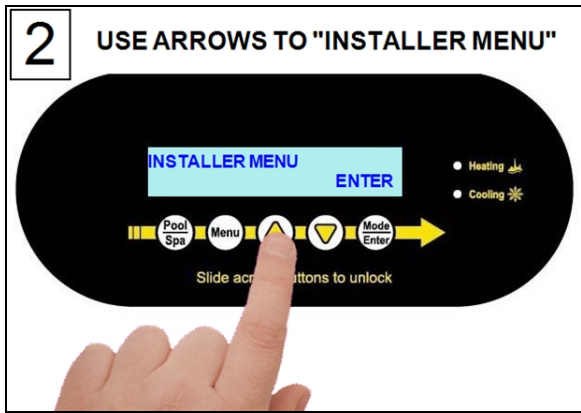
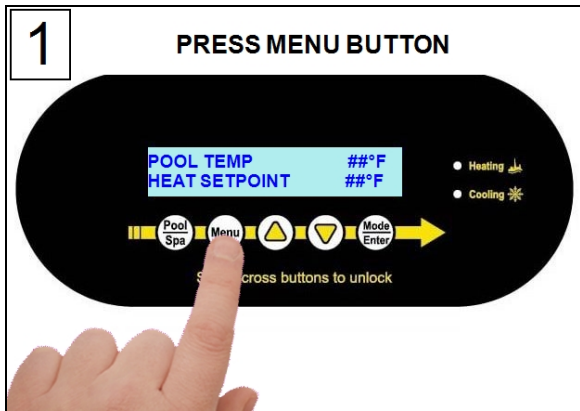
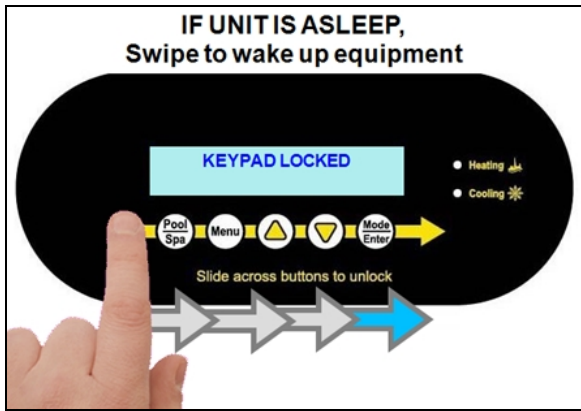

8 USE ARROWS TO CHANGE TO "SCHEDULED"

SET BACKUP HEAT MODE SCHEDULED

- Heating
- Cooling

Pool Spa Menu Mode Enter

Slide across buttons to unlock

9 ENTER TO SAVE

SET BACKUP HEAT MODE SCHEDULED

- Heating
- Cooling

Pool Spa Menu Mode Enter

Slide across buttons to unlock

10 USE ARROWS TO MENU "SET BACKUP GAS START"

SET BACKUP GAS START SCHEDULE 09:00AM

- Heating
- Cooling

Pool Spa Menu Mode Enter

Slide across buttons to unlock

11 ENTER TO EDIT

SET BACKUP GAS START SCHEDULE 09:00AM

- Heating
- Cooling

Pool Spa Menu Mode Enter

Slide across buttons to unlock

12 USE ARROWS TO CHANGE TO ACTUAL CIRCULATION PUMP START TIME

SET BACKUP GAS START SCHEDULE 09:30AM

- Heating
- Cooling

Pool Spa Menu Mode Enter

Slide across buttons to unlock

13 ENTER TO SAVE

SET BACKUP GAS START SCHEDULE 09:30AM

- Heating
- Cooling

Pool Spa Menu Mode Enter

Slide across buttons to unlock

14 USE ARROWS TO MENU "SET BACKUP GAS END"

SET BACKUP GAS END SCHEDULE 05:00PM

- Heating
- Cooling

Pool Spa Menu Mode Enter

Slide across buttons to unlock

15 ENTER TO EDIT

SET BACKUP GAS END SCHEDULE 05:00PM

- Heating
- Cooling

Pool Spa Menu Mode Enter

Slide across buttons to unlock

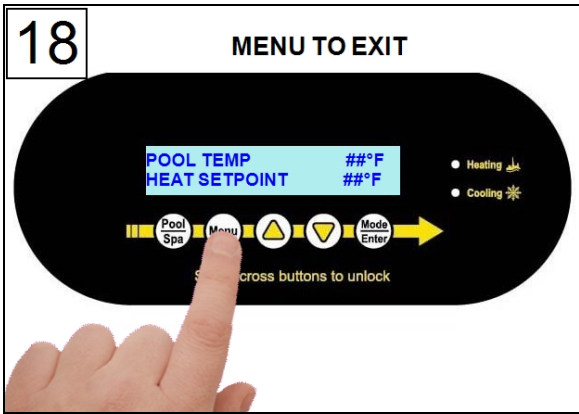
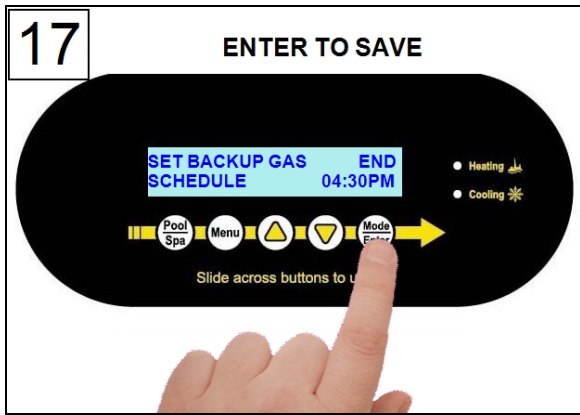
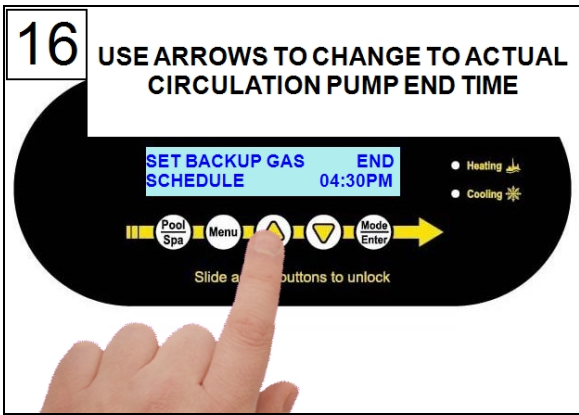

1.6.d Connecting Multiple Heat Pumps (Master / Slaved)

Up to 16 heat pumps can be connected and controlled from a primary heat pump.

There are two reasons for using a multiple heat pump configuration:

1. Controlling multiple heat pumps from one location; the master heat pump.
2. Preventing heat pumps from starting up at the same time and causing an excessive power draw on the electric circuit.

DANGER

Failure to heed the following will result in injury or death.

- Deactivate power while routing wiring to control board.

WARNING

Failure to heed the following may result in injury or death.

- This section is only for qualified installers who are familiar with swimming pool and spa safety standards.
- The installer must be familiar with service industry techniques.

NOTICE

Failure to heed the following may result in damage to equipment.

- The wire size connecting the heat pumps must be 22-gauge, 2-conductor, low-voltage wire. Be sure that the size of the wire will allow at least two wires per connection point.
- Do not attempt to connect heat pump equipment in a multiple configuration with previous HP7 and HP7R versions of the microprocessor. See Figure 7. No on-board connections are provided for heat pumps with these microprocessor versions. An Automatic Sequencing Controller (ASC) accessory is required for those types of heat pumps.

DO NOT CONNECT HP7 or HP7R boards

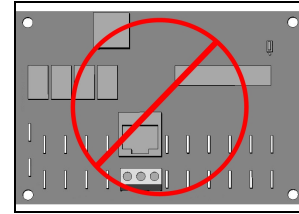

Figure 7

Connecting Multiple Heat Pumps

1. Choose one unit to be the lead (or master) unit. This is typically a unit that can be accessed easily when temperature adjustments are needed.
 - Note - The Lead unit can be connected to an external controller via the "smart bus" connection point if desired.
2. Deactivate power to heat pumps.
3. Remove electrical access panels.
4. Route 22-gauge, 2-conductor, low-voltage wires to the low voltage sides of the electrical enclosures. Follow all National Electric Codes (NEC) and / or State and Local guidelines.
5. Connect the first slaved heat pump's wires to the unit selected as the master heat pump's.
6. Use "Port C" on the microprocessors as indicated. Connecting the "Y" to the "Y" and the "B" to the "B" on each heat pump's port "C" connection point. The "G" and "R" connection points are not used. See Figure 8.
7. Connect any additional heat pumps as indicated, doubling up the wires as shown. See Figure 9. Confirm the same color wires connect to the same wires on each heat pump ("Y" to "Y" and "B" to "B"). Up to 16 heat pumps can be controlled by one heat pump.
8. Label the heat pumps appropriately as a master unit and slaved units (Master, Slaved 01, Slaved 02, etc.) to simplify configuration and future operation.
9. Reattach access panels.
10. Apply power to master heat pump. Confirm the mode is set to "**SYSTEM OFF**".
11. Apply power to the next heat pump and confirm the mode is set to "**SYSTEM OFF**". Do this for each heat pump.
12. Program heat pumps with assigned addresses. (See "Configuring Multiple Heat Pumps" in this section.)

Dry Contact Connection Points to the Microprocessor

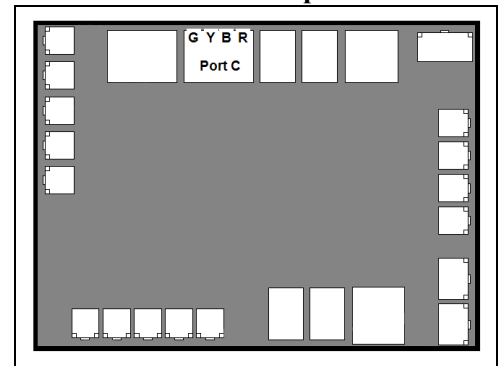

Figure 8

Multiple Heat Pump Connection Points to "Port C"

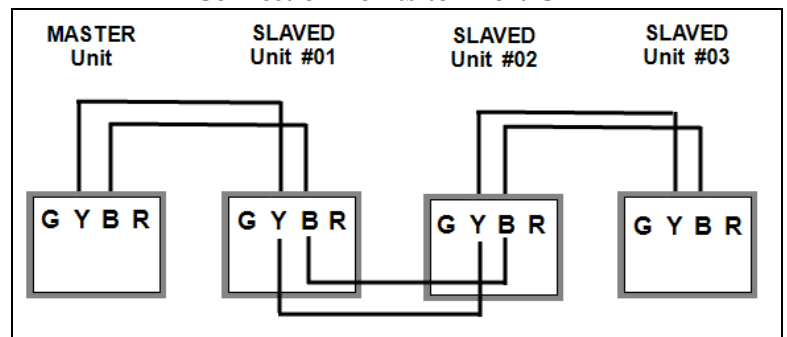
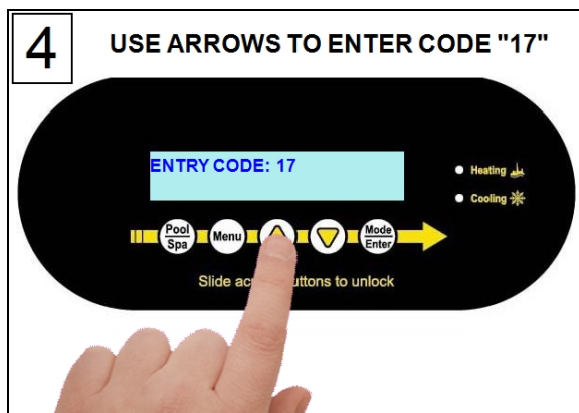
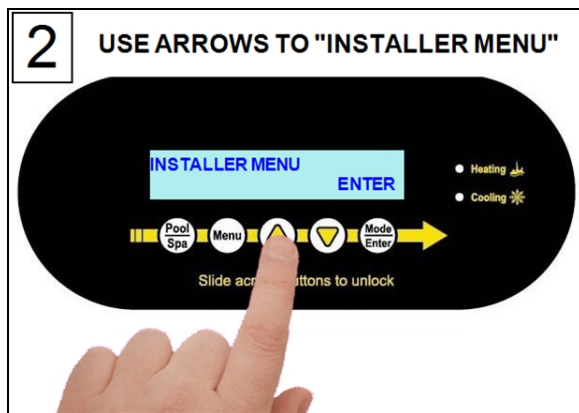
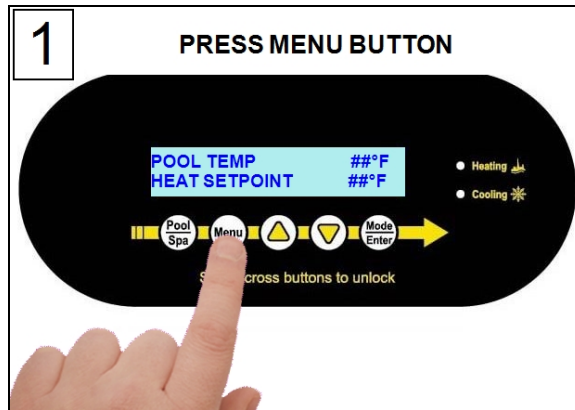
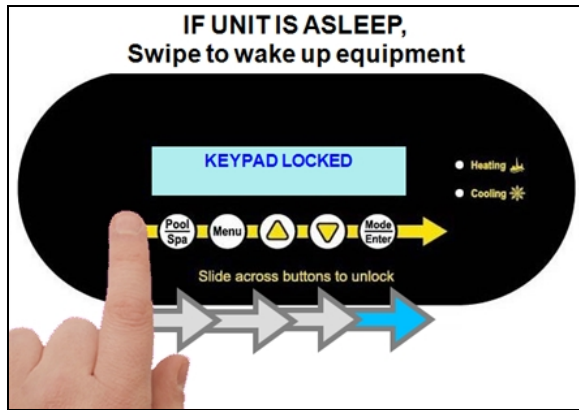

Figure 9

Configuring Multiple Heat Pumps

Master (Primary) Heat Pump

Confirm the first connected heat pump is designated as the master (primary) unit.



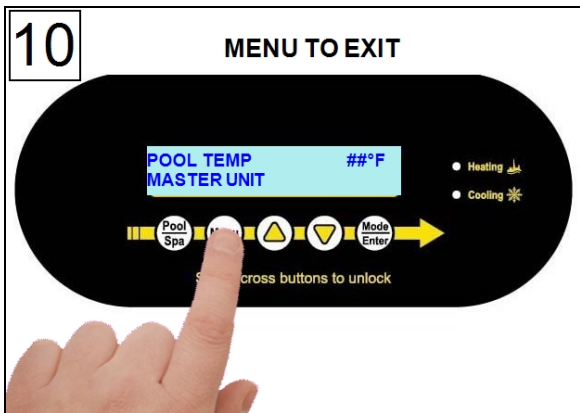
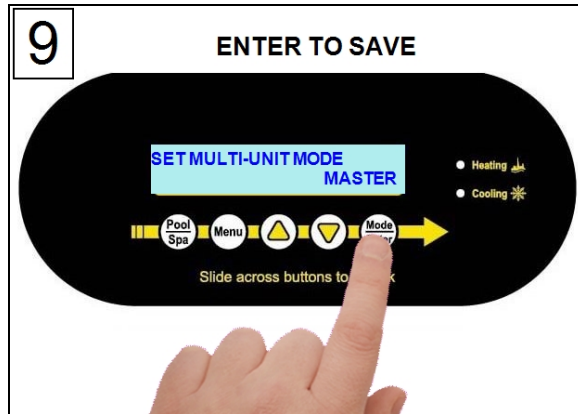
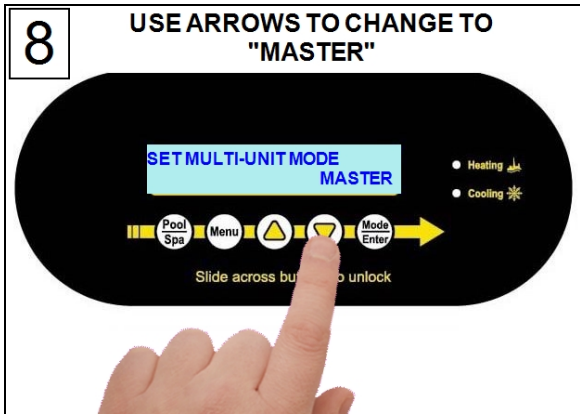
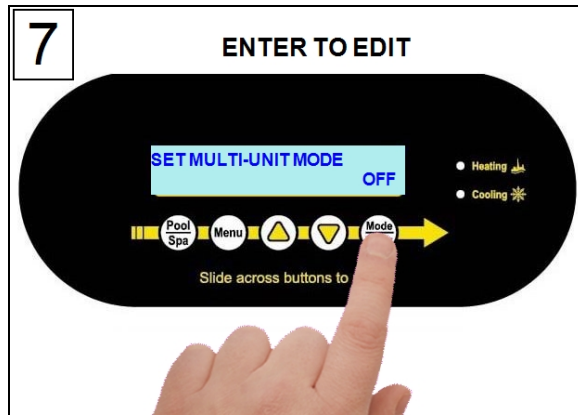
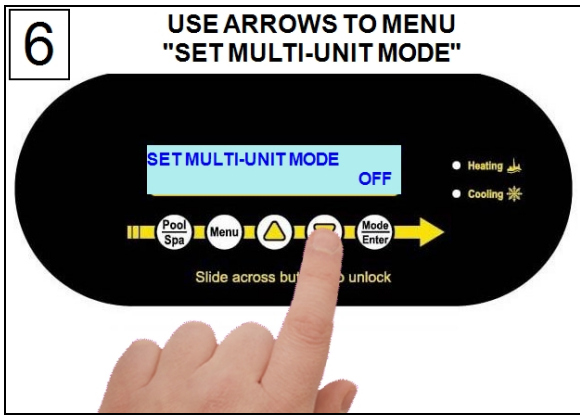

Slaved (Secondary) Heat Pumps

Go to the next connected heat pump and configure it as a slaved unit with a heat pump address of "01". Each additionally connected heat pump will require a unique heat pump address ("02", "03", etc.)

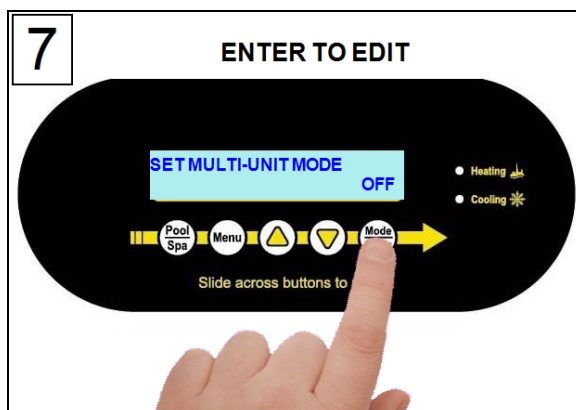
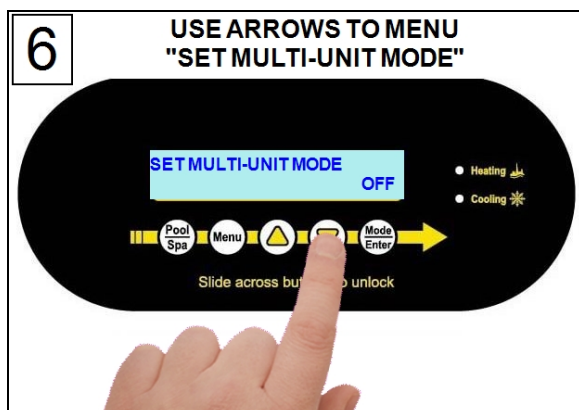
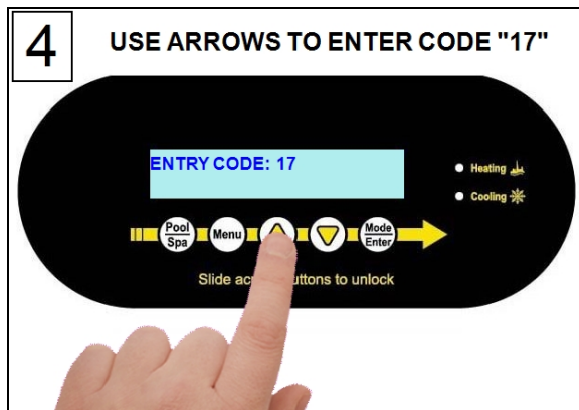
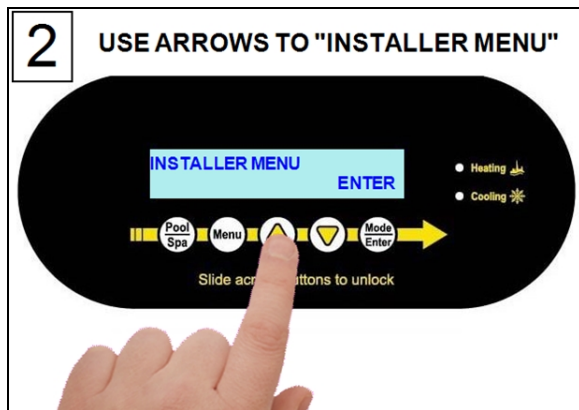
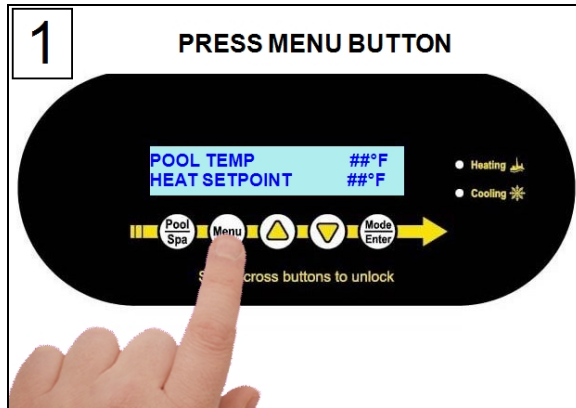
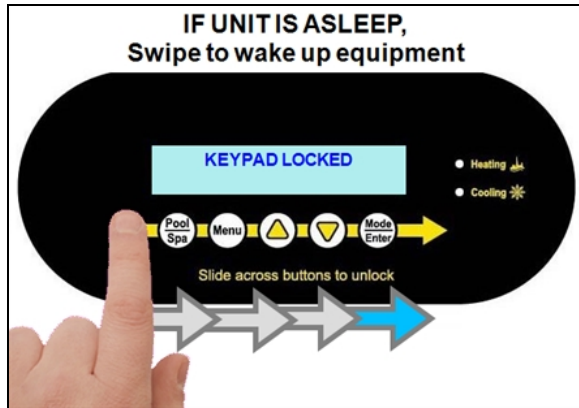

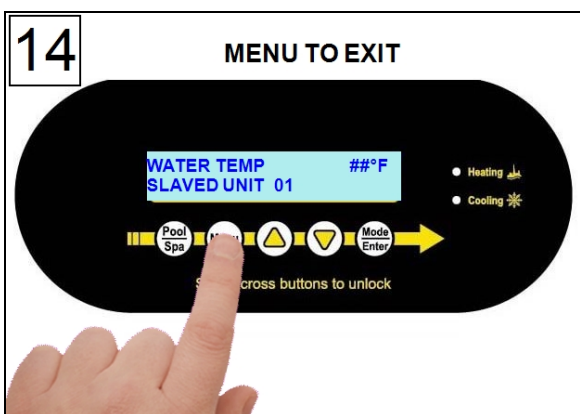
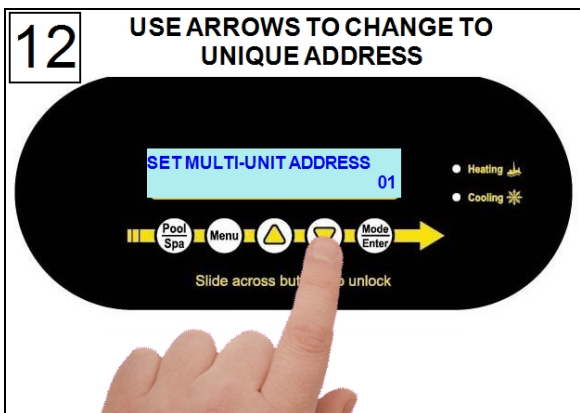
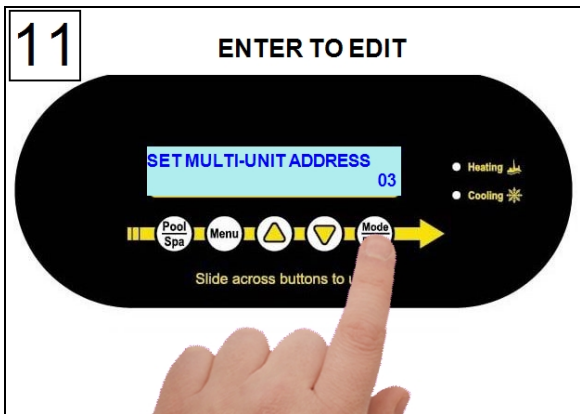
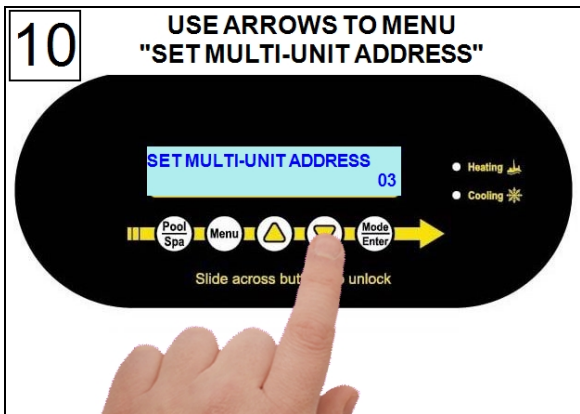
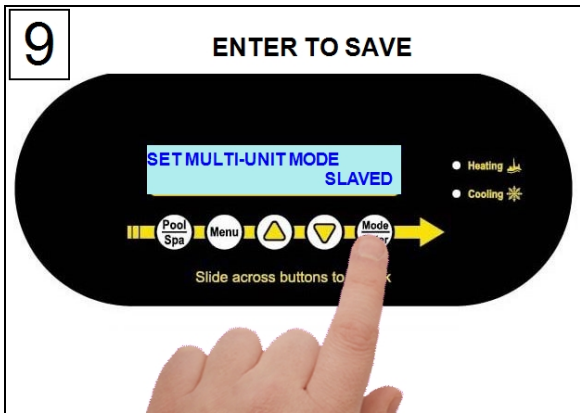
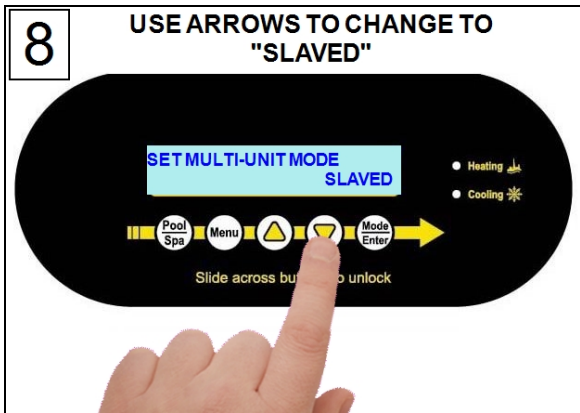

1.6.e Connecting Optional Automatic Thermostat Switching

A direct connection to an external flow relay switch has been provided on the terminal microprocessor. A pool / spa relay switch will automatically change between the pool or spa thermostat depending on how the actuators are set.

- When water flows to the pool, the pool thermostat will be used.
- When water flows to the spa, the spa thermostat will be used.

PLEASE NOTE:

Once the "Pool / Spa Relay Switch" has been activated, the "POOL / SPA" button will be deactivated.

For more information on this accessory, see "Grid Flow Switch (# 0040S)" on page 71.

DANGER

Failure to heed the following will result in injury or death.

- Deactivate power while routing wiring to control board.

WARNING

Failure to heed the following may result in injury or death.

- This section is only for qualified installers who are familiar with swimming pool and spa safety standards.
- The installer must be familiar with service industry techniques.

NOTICE

Failure to heed the following may result in damage to equipment.

- The wire size connecting the relay switch must be a minimum 22-gauge, 2-conductor, low-voltage wire.
- Use FS2 (**dry contact**) connection on the microprocessor.

Connecting Switch

1. Deactivate power to heat pump.
2. Plumb the switch as indicated in accessories installation instructions.
3. Remove heat pump electrical access panel.
4. Using two of the three wires from the installed switch, route wires to the low voltage side of the electrical enclosure. The third wire is not used. Follow all National Electric Codes (NEC) unless State or Local guidelines supersede.
5. Connect the wires to the jumper provided. Polarity is not important.
6. Reattach heat pump access panel.
7. Apply power to heat pump.
8. Configure heat pump to accept the pool / spa relay switch (See "Configuring Switch" in this section.)

Dry Contact Connection Points to the Microprocessor

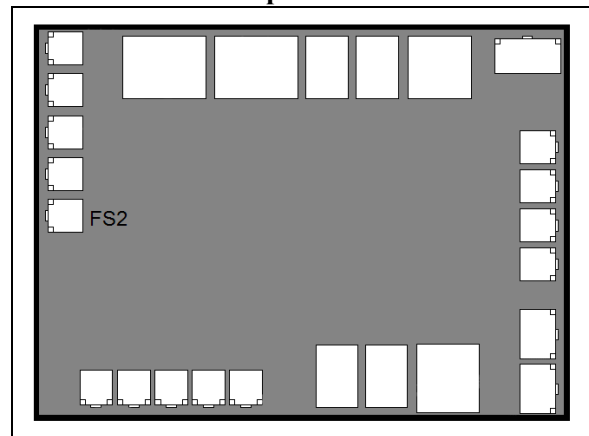

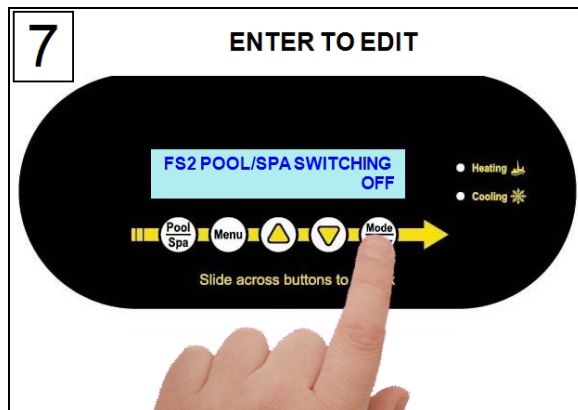
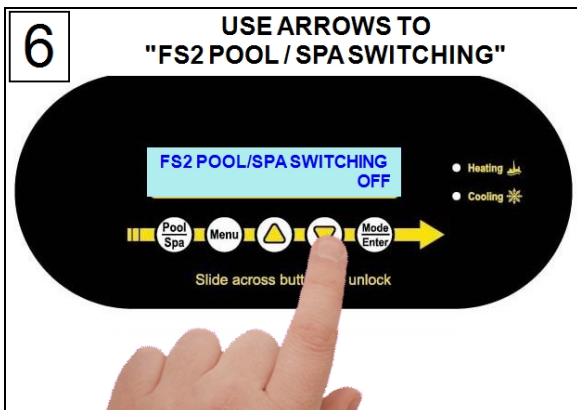
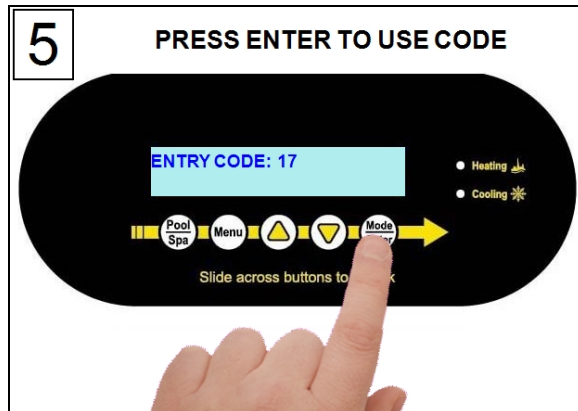
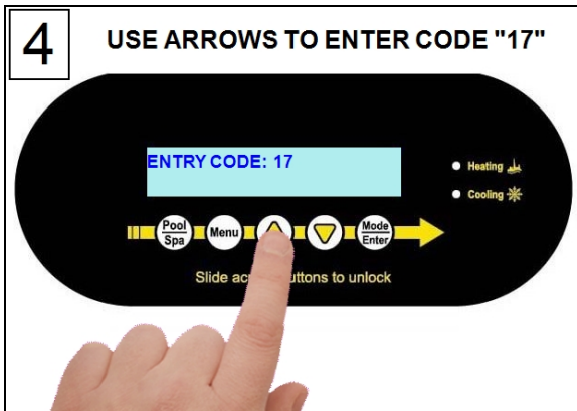
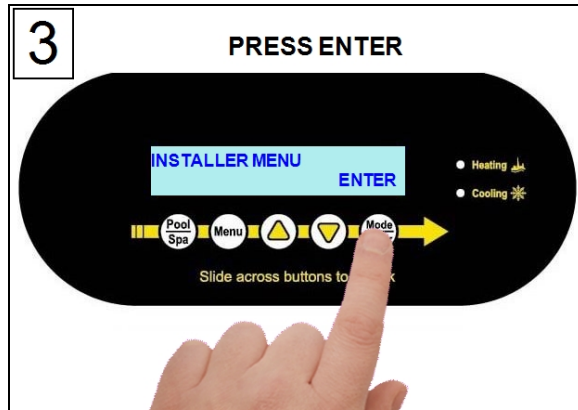
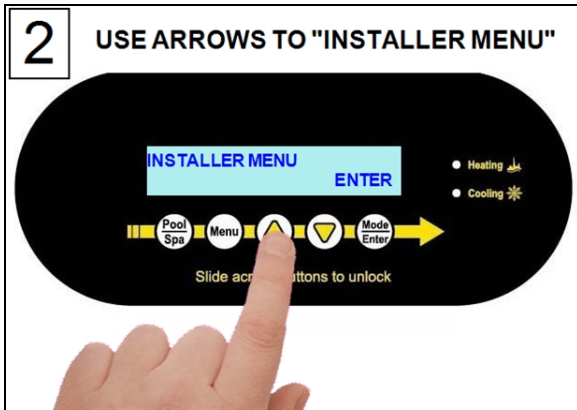
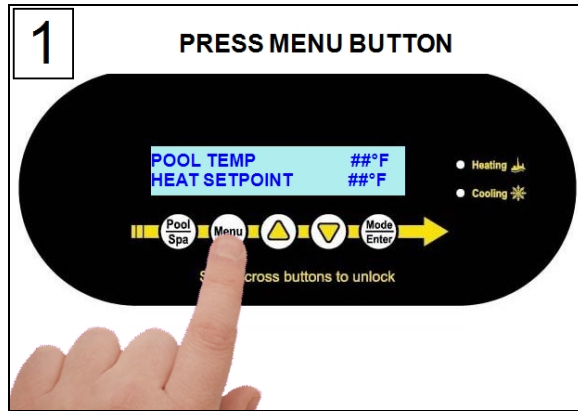
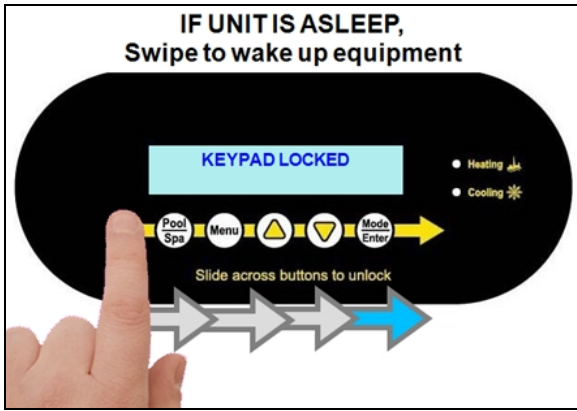

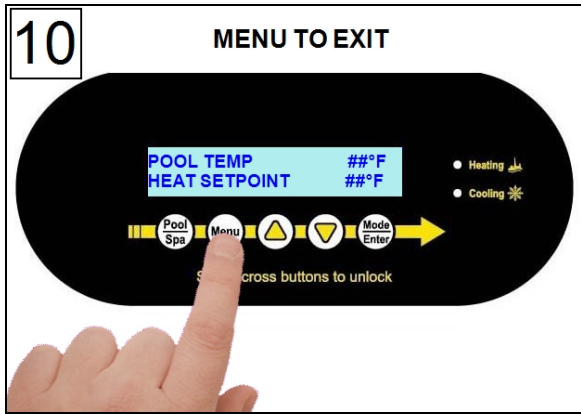
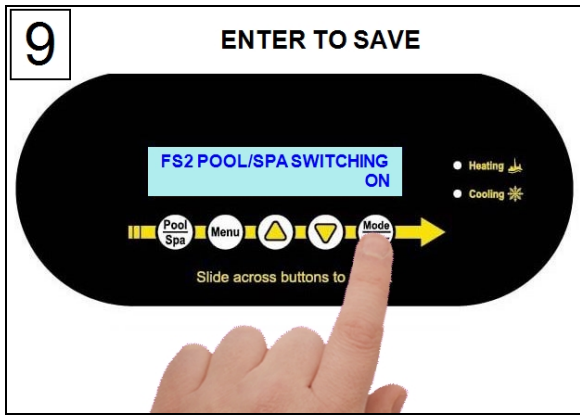
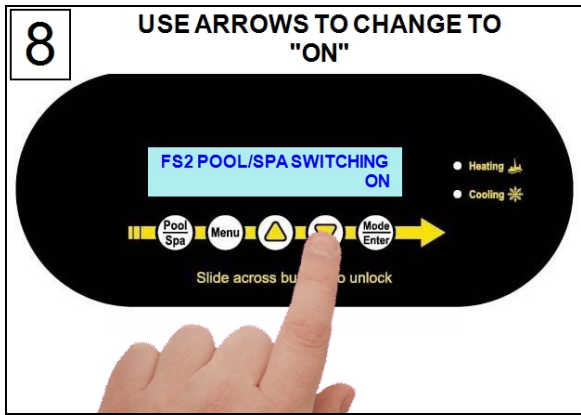

1.7 Program Heat Pump for the Customer

1.7.a Setting Date and Time

Set the heat pump's time and date using the following steps.

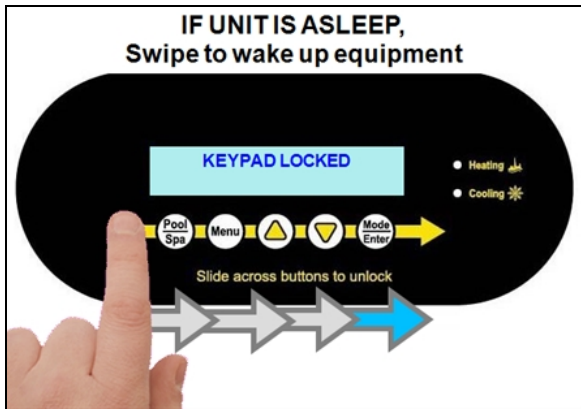

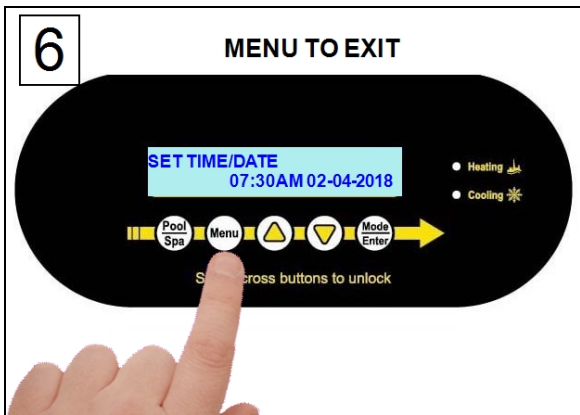
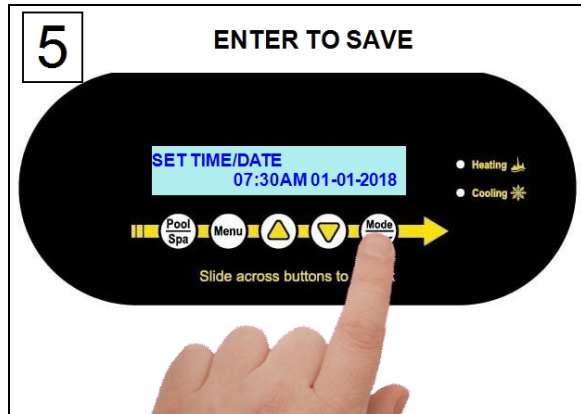
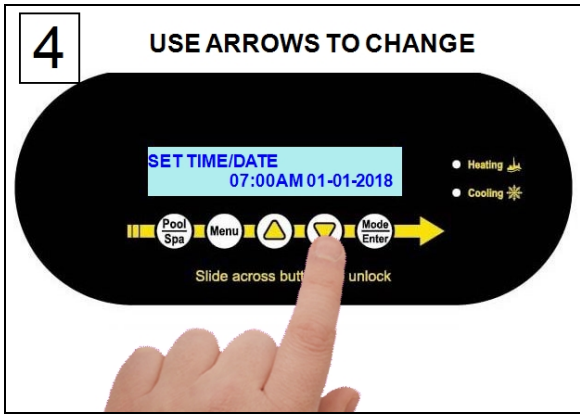
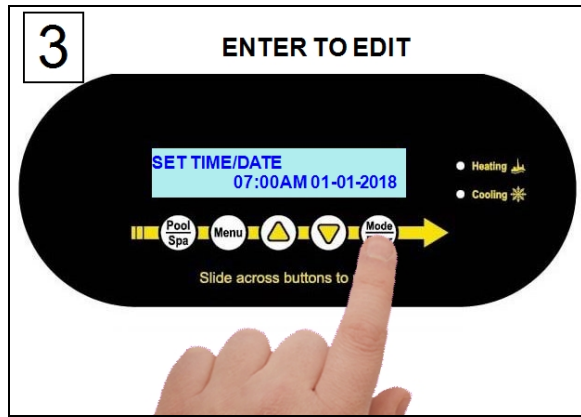
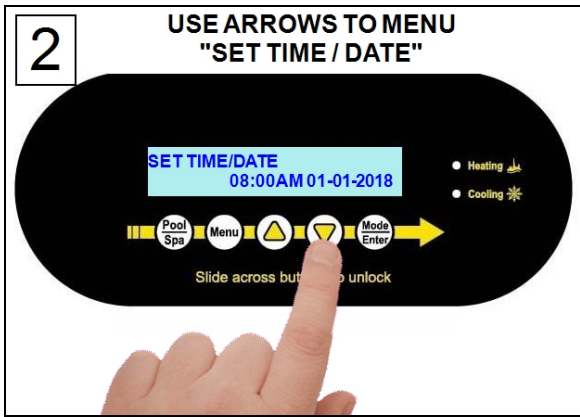

1.7.b Setting Date and Time Format

The heat pump's time and date format can be customized.

Customize Time

The time can be displayed in 24 hour *military* time (the default display is 12 hour).

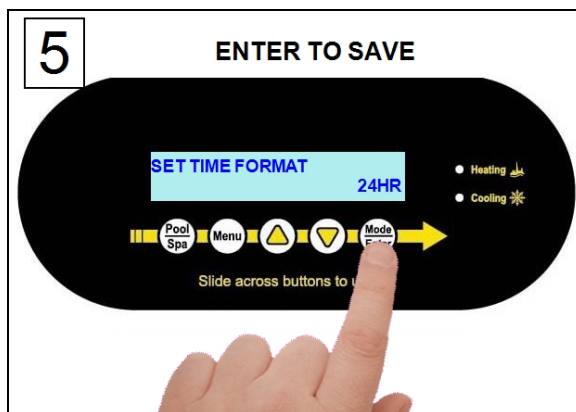
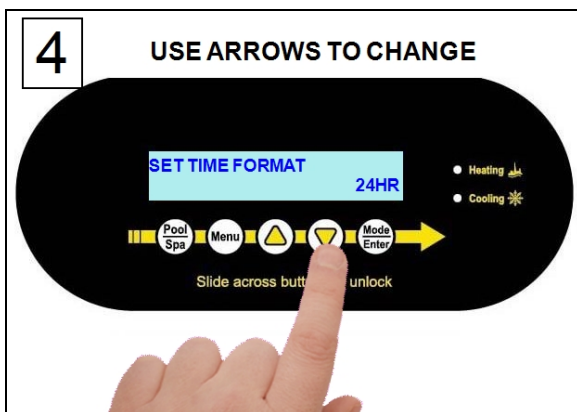
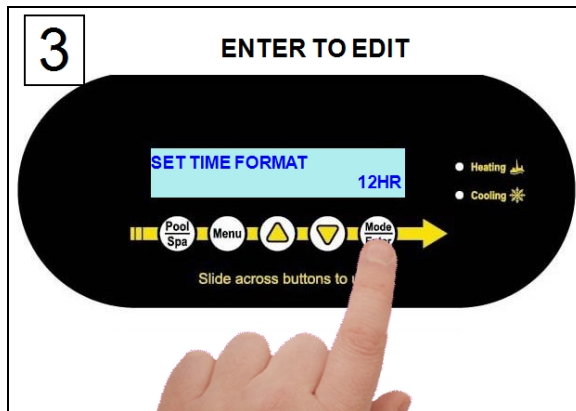
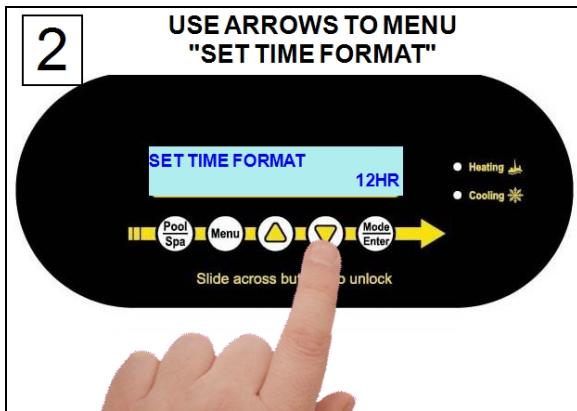
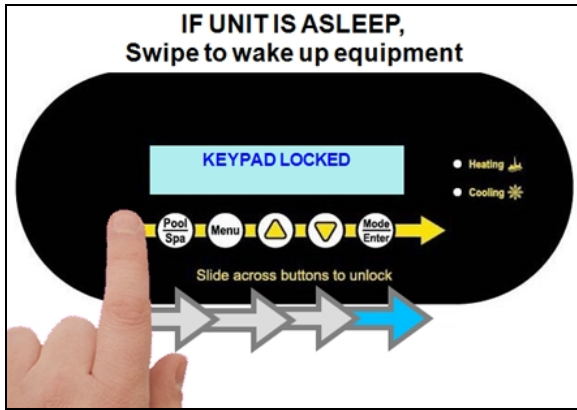

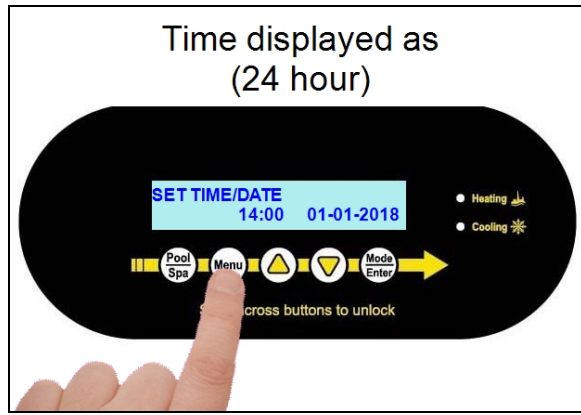
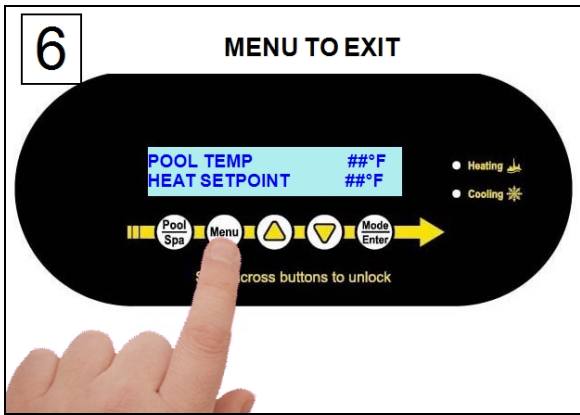

Customize Date

The date can be displayed as Day-Month-Year (the default is Month-Day-Year).

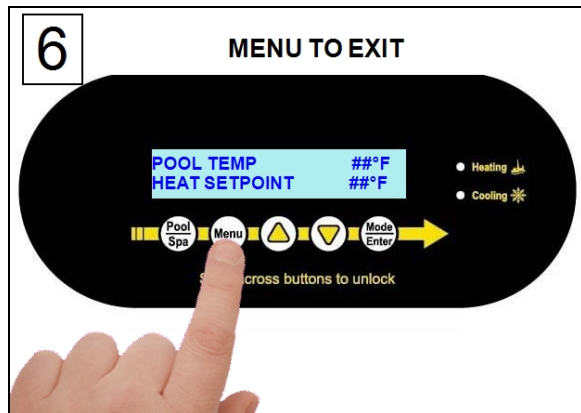
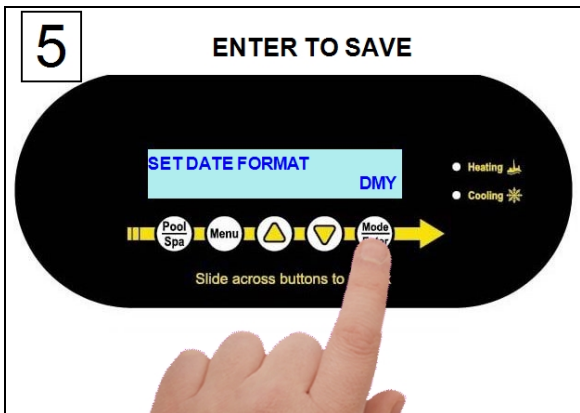
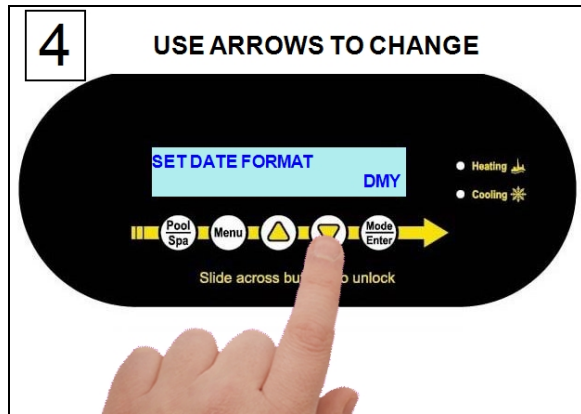
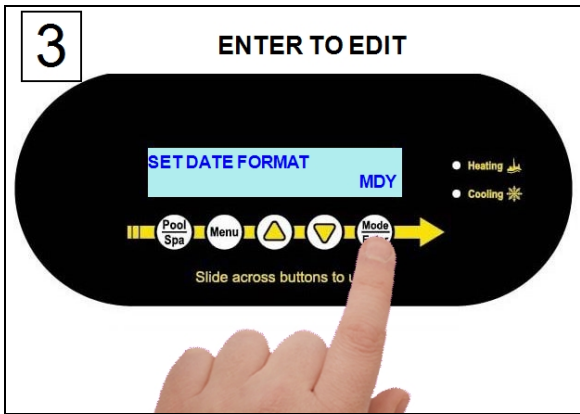
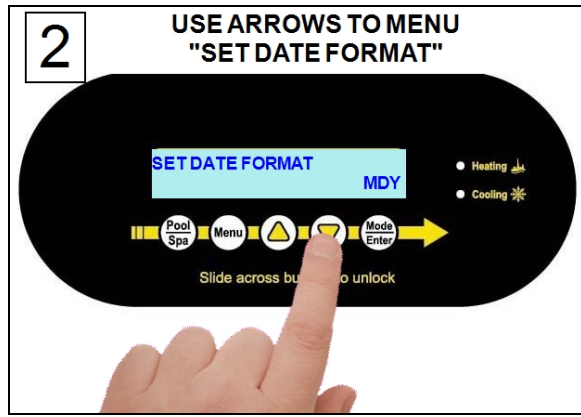
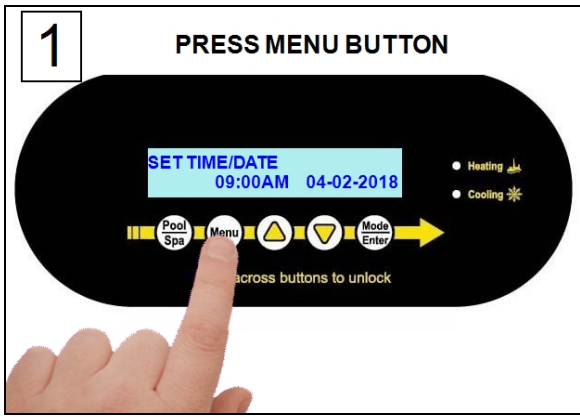

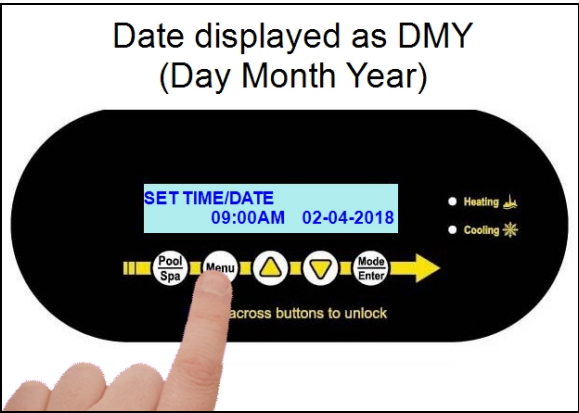

1.7.c Selecting Celsius or Fahrenheit

Set the water temperature to show in either Fahrenheit (default) or Celsius.

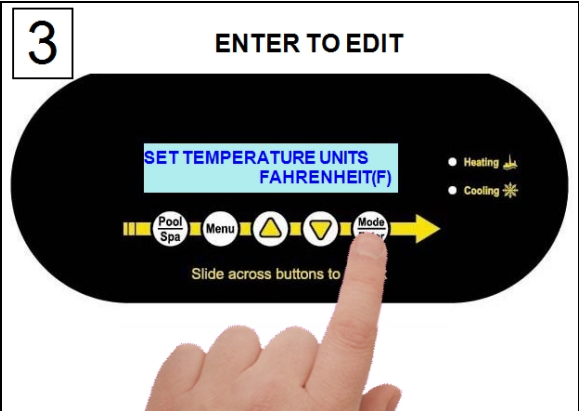
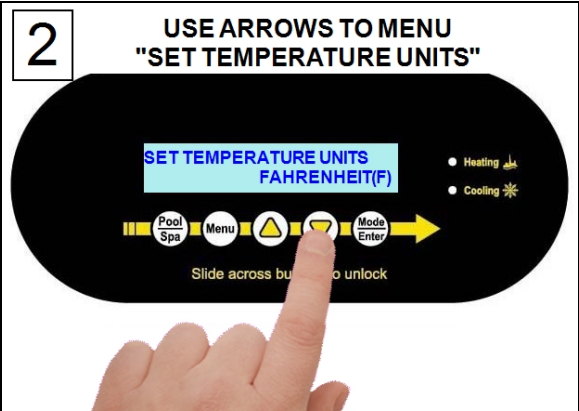
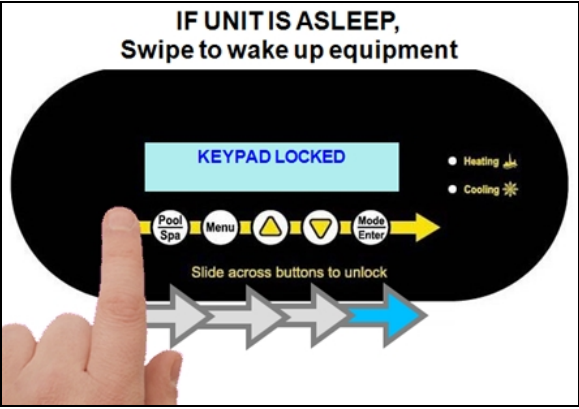

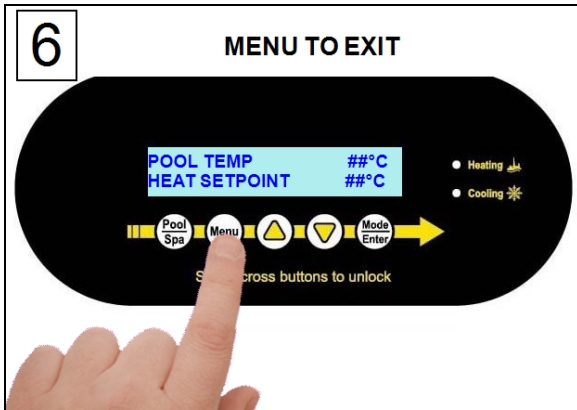
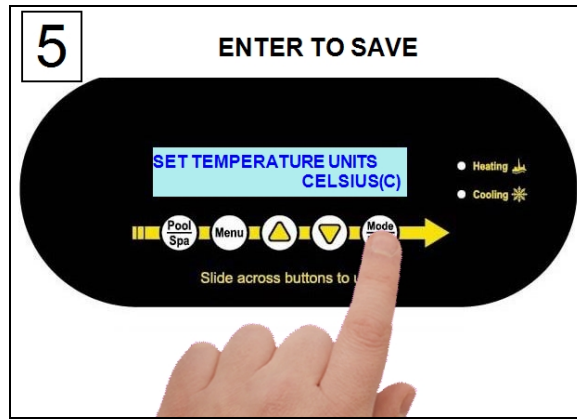
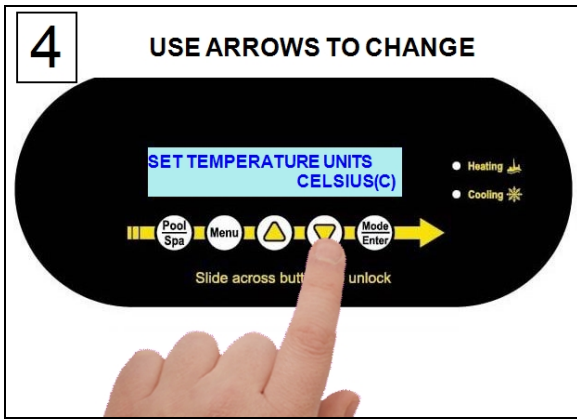

1.7.d Setting Entry Code Option

The entry code feature can prevent unauthorized temperature adjustments. This feature initiates after the heat pump goes into the sleep mode for the first time.

NOTICE

Failure to heed the following may result in damage to equipment.

- **Before enabling the entry code feature, be sure to record the code.** If lost, the heat pump will require a program reset to regain access. This reset may require additional configuration by the installer.

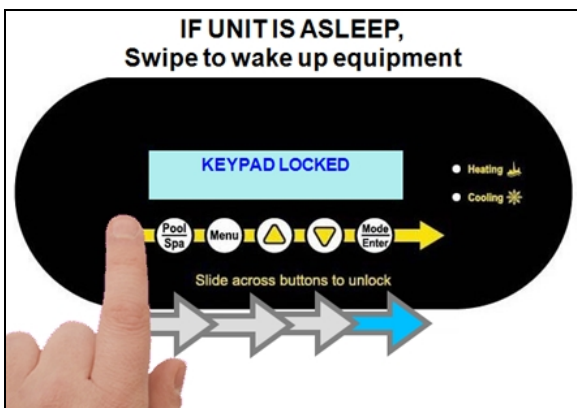

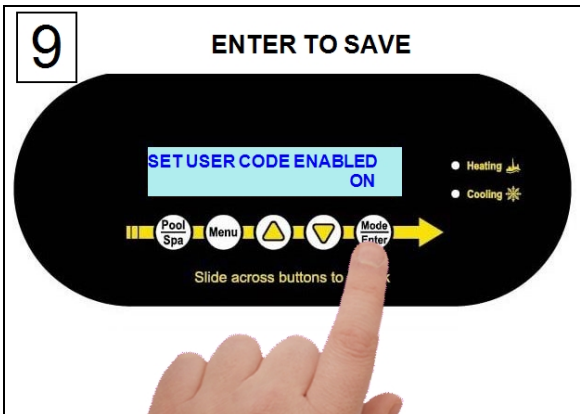
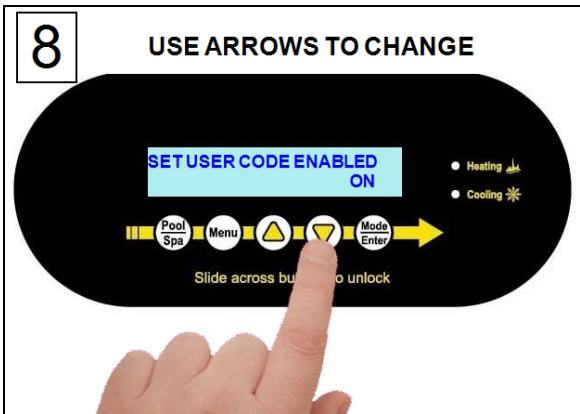
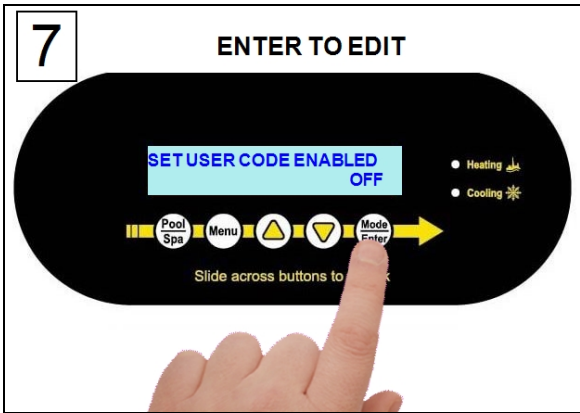
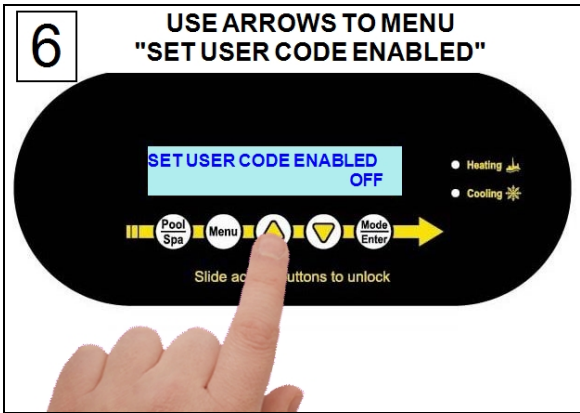
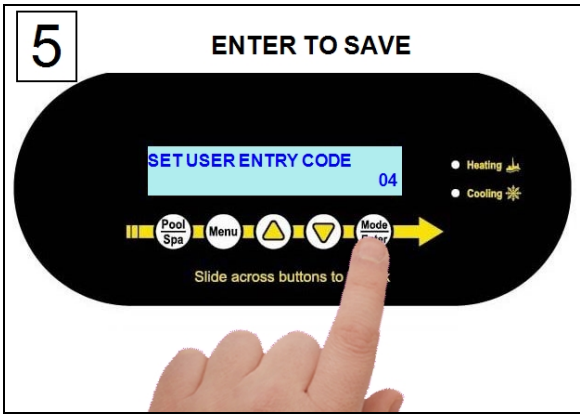
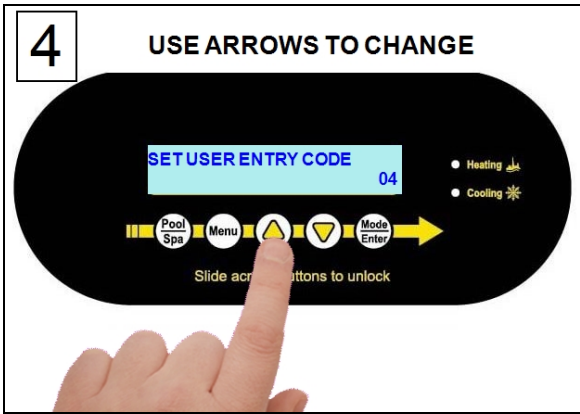
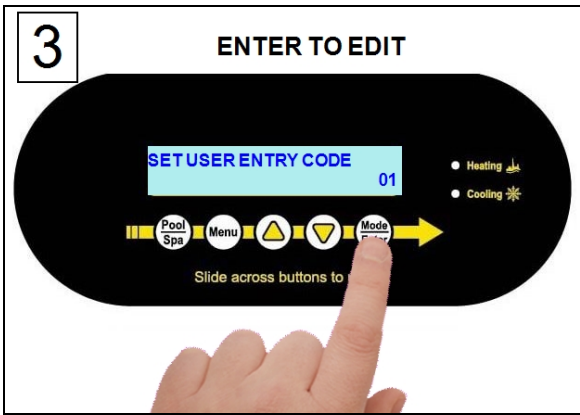
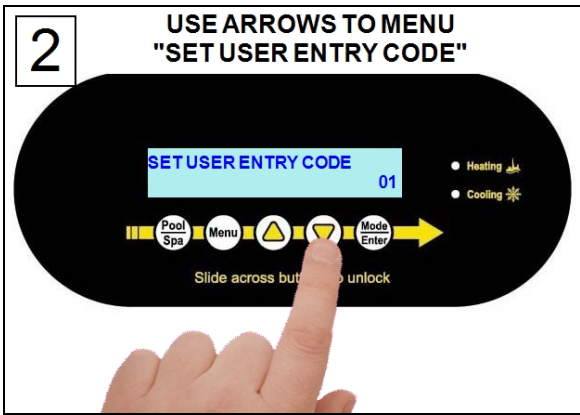

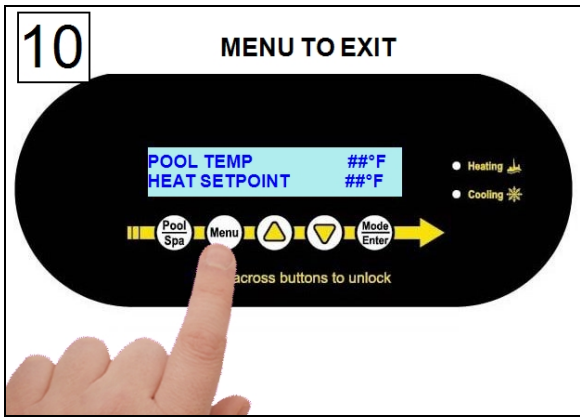

1.7.e Using Entry Code to Access Heat Pump

If a user entry code has been enabled in the user menu, an entry code will be required to access heat pump options.

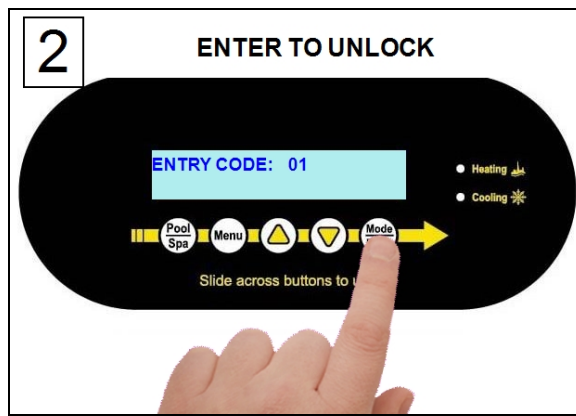
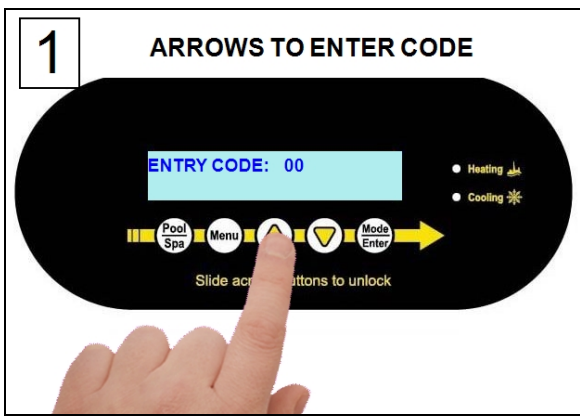

PLEASE NOTE -

- If the entry code has been misplaced, the heat pump will need to be reset to factory defaults.
- After three minutes of inactivity, the heat pump's sleep mode will activate.

1.7.f Resetting Factory Defaults

If needed, the installer can reset programming to the heat pump's factory default settings.

PLEASE NOTE:

This will reset any external device configurations.

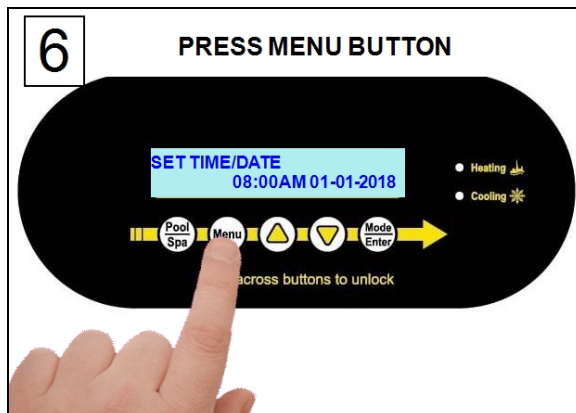
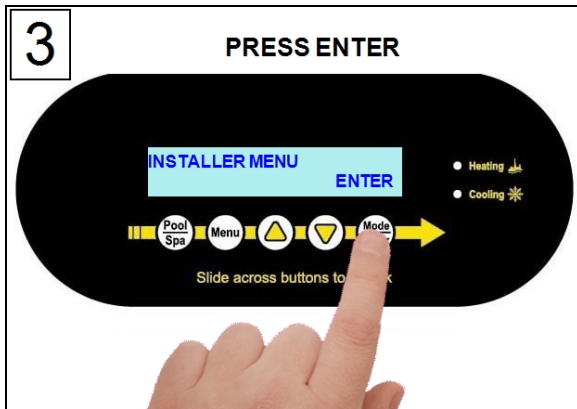
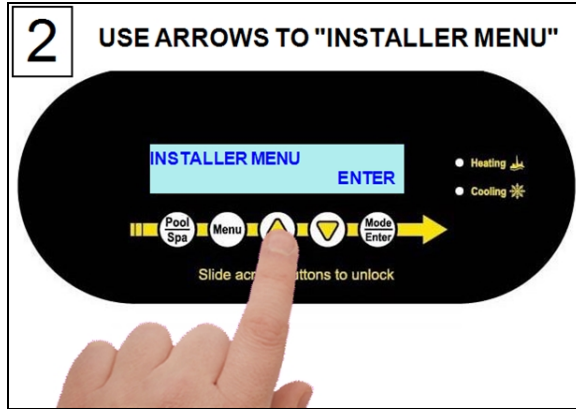
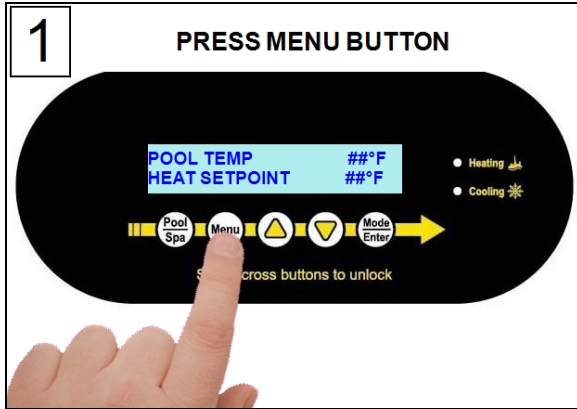

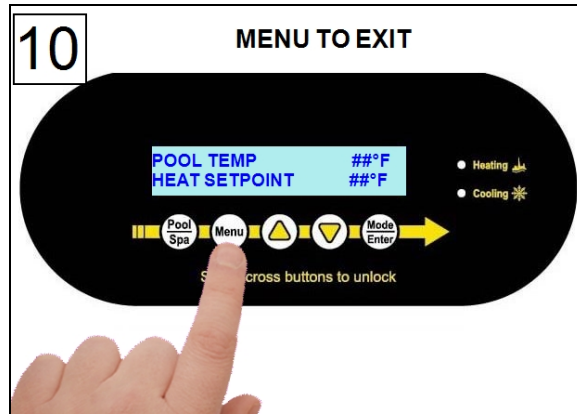
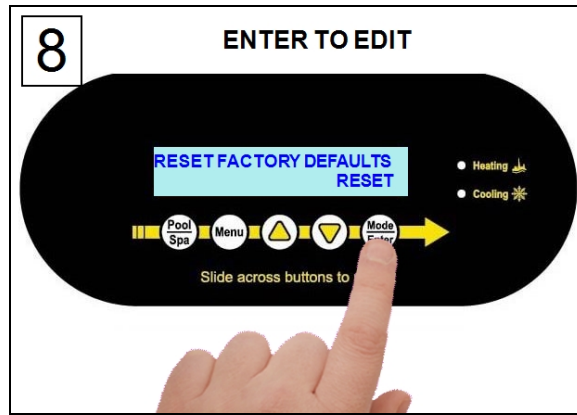
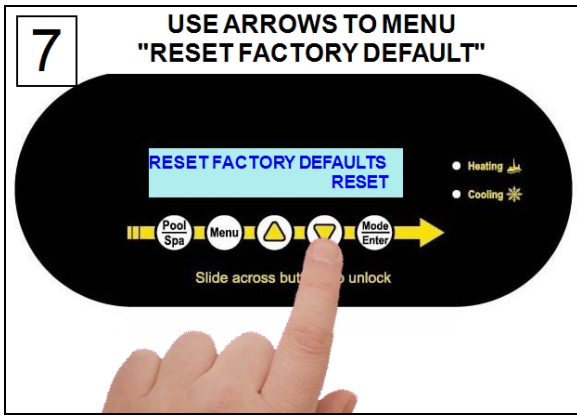

1.8 Cleaning Equipment After Installation

Installer - If you need to clean equipment after installation, please use the following guidelines.

WARNING

Failure to heed the following may result in injury or death.

- Possible electric shock hazard - Deactivate power to all electrical devices on the pad when washing heat pump. Do not restore electrical power until equipment is completely dry.

NOTICE

Failure to heed the following may result in damage to equipment.

- Do not use a pressure cleaner to wash heat pump. Damage to heat pump components may result. If using a hose-end spray nozzle adjust spray pattern to low strength only.
- Do not spray water directly into the interior of the heat pump; damage to components may result.
- Do not use chemicals on the display panel.

Cleaning

1. Wash outside cabinet using a low-pressure water hose. A high-pressure water stream will cause damage to the aluminum fins of the heat pump. This damage is not covered under product warranty.
2. While the heat pump is still wet, use an approved cleaning agent to clean the exterior of the heat pump. **Do not use chemicals on the display panel.**
3. Use a detergent-dampened cloth to wipe the heat pump's exterior cabinet.
4. Flush all exterior with fresh water using a low-pressure water hose.
5. Dry the exterior cabinet using a soft cloth being careful not to damage fins.

APPROVED CLEANING AGENTS*
Fantastic®
Formula 409®
Cascade®
All Power Plain Detergent (3% Solution)

Table 3 - Cleaning Agents

- * The trademarks used in approved cleaning agents are property of their owners and are not related to AquaCal®.

Polishing

1. Polish the heat pump's cabinet panels using an approved polishing agent and following the manufacturer's instructions. Do not use chemicals on the display panel.
2. Rinse the heat pump panels with fresh water, wipe, and buff panels using a dry soft cloth.
3. Allow heat pump interior and surrounding equipment to "air-dry" for several hours prior to restoring electrical power.

APPROVED POLISHING AGENTS*
Simoniz® Wax
Glo-Coat®
Armor All® Protectant

Table 4 - Polishing Agents

- * The trademarks used in approved polishing agents are property of their owners and are not related to AquaCal®.

IN THIS SECTION:

Fault Codes

AIR TEMP SENSOR OPEN or AIR TEMP SENSOR SHORT	56
CLOCK LOW BATTERY	56
DEFROST1 SENSOR OPEN or DEFROST2 SENSOR OPEN	56
DEFROST1 SENSOR SHORT or DEFROST2 SENSOR SHORT	56
ERROR AT MASTER UNIT	56
HIGH PRESSURE FAULT	57
HIGH WATER TEMPERATURE	58
HP5 SYSTEM LOCKOUT	58
LOW PRESSURE FAULT	59
LP5 SYSTEM LOCKOUT	59
MULTI-UNIT COMM FAULT	60
OTA SYSTEM LOCKOUT	60
SMART COMM FAULT	60
WATER TEMP SENSOR SHORT or WATER TEMP SENSOR OPEN	60

Issues and resolutions

Blank Display	61
Display Panel Not Responding	61
Displays "DEFROSTING"	62
Displays "NO SYSTEM FIRMWARE"	62
Displays "NO POOL/SPA WATER FLOW"	62
Displays "SET TO SWITCH REMOTELY"	63
Displays "SET UNIT MODEL NUMBER"	63
Heat Pump Not Running	63
Heat Pump's Tripping Breaker	63
Heat Pump Won't Shut Off	64
Heat Pump Is Running, Not Heating	64
Heat Pump Is Running, Not Cooling	65
Ice Forming on the Heat Pump	66
"Pool / Spa" Button Will Not Work	66
Water Coming From Heat Pump	67

2.1 Fault Codes

A fault code indicates a specific issue or condition that will require action before the equipment can resume operating.

Please perform the following troubleshooting.

If the issue reoccurs, please see "*Contacting AquaCal AutoPilot, Inc.*" on page 1.

WARNING

Failure to heed the following may result in injury or death.

- Repairs must not be attempted by untrained or unqualified individuals.
- The heat pump contains refrigerant under high pressure. Repairs to the refrigerant circuit must not be attempted by untrained or unqualified individuals. Service must be performed only by qualified HVAC technicians. Recover refrigerant before opening the system.

NOTICE

Failure to heed the following may result in damage to equipment.

- Service by unauthorized personnel will void the heat pump warranty.

AIR TEMP SENSOR OPEN or AIR TEMP SENSOR SHORT**ISSUE**

Open or shorted air sensor.

RESOLUTION

A qualified technician should replace the air sensor.

CLOCK LOW BATTERY**ISSUE**

The real-time clock controller indicates a low battery condition.

- The time will reset to factory default.
- If connected, a gas backup heater may start and stop at an incorrect time when set for "SCHEDULED" mode.

RESOLUTION

A qualified technician should replace the battery. The date and time will need to be reset on the heat pump after replacement.

DEFROST1 SENSOR OPEN or DEFROST2 SENSOR OPEN**ISSUE**

Open defrost sensor.

RESOLUTION

A qualified technician should replace the defrost sensor.

DEFROST1 SENSOR SHORT or DEFROST2 SENSOR SHORT**ISSUE**

Shorted defrost sensor.

RESOLUTION

A qualified technician should replace the defrost sensor.

ERROR AT MASTER UNIT**ISSUE**

The heat pump is slaved to a master heat pump that is displaying a fault code.

RESOLUTION

The error at the master heat pump must be corrected before the slaved unit will resume operation.

ISSUE

The refrigerant system's high-pressure switch is showing as open.

RESOLUTION

Heat Only Units

Place heat pump in heating mode and perform the following troubleshooting.

Determine if an insufficient amount of water is being supplied to the equipment.

1. Confirm the filter pump is on.
2. If a multiple-speed filter pump is being used, run filter pump at a higher speed. Do not exceed maximum flow rate for the model.
3. Confirm water is not being diverted away from the heat pump.
 - See "Water Flow Rates" on page 11.
 - See "Adjusting Water Flow Using ΔT (Delta-T)" on page 13.
4. The water pressure switch may be incorrectly calibrated.
 - See "Adjusting Water Pressure Switch" on page 14.

Cool Only Units

Determine if an insufficient amount of air is being supplied to the equipment.

1. Check for proper fan operation. If fan is not operating, contact AquaCal® Technical Support.
2. Check for obstructed air flow around the heat pump.
 - See "Clearances" on page 5.
3. Check for dirty or blocked evaporator coil.
 - See "Cleaning Equipment After Installation" on page 53.

Heat and Cool Units (Reversing)

Place heat pump in heating mode and perform the following troubleshooting.

Determine if an insufficient amount of water is being supplied to the equipment.

1. Confirm the filter pump is on.
2. If a multiple-speed filter pump is being used, run filter pump at a higher speed. Do not exceed maximum flow rate for the model.
3. Confirm water is not being diverted away from the heat pump.
 - See "Water Flow Rates" on page 11.
 - See "Adjusting Water Flow Using ΔT (Delta-T)" on page 13.
4. The water pressure switch may be incorrectly calibrated.
 - See "Adjusting Water Pressure Switch" on page 14.

HIGH WATER TEMPERATURE

ISSUE

Incoming water temperature has exceeded 110° F (43° C) and the unit has been deactivated. The heat pump will not operate until incoming water temperature drops to 100° F (38° C) or lower.

RESOLUTION

1. Determine if a gas heater is sending water directly to the heat pump. This situation would need to be corrected before continuing.
2. If a solar heater is sending water directly to the heat pump, the water can initially be hotter than 110° F (43° C). After the water from the solar panel normalizes, the fault will no longer display and the heat pump will resume as needed.
3. If the **HIGH WATER TEMPERATURE** fault continues to display, the water temperature sensor may require replacement.

HP5 SYSTEM LOCKOUT

ISSUE

The heat pump has locked due to five high-pressure faults during one call for heating or cooling.

RESOLUTION

1. Deactivate then reactivate power to the heat pump to clear error.
2. Troubleshoot the high-pressure issue causing the error.
 - See "HIGH PRESSURE FAULT" on page 57.

LOW PRESSURE FAULT

ISSUE

The refrigerant system's low-pressure switch is showing as open.

RESOLUTION

Heat Only Units

Place heat pump in heating mode and perform the following troubleshooting.

1. Check for proper fan operation. If fan is not operating, contact AquaCal® Technical Support.
2. Check for obstructed air flow around the heat pump.
 - See "Clearances" on page 5.
3. Check for dirty or blocked evaporator coil.
 - See "Cleaning Equipment After Installation" on page 53.
4. Check for signs of heavy ice buildup on the coil.

Cool Only Units

Place heat pump in heating mode and perform the following troubleshooting.

Determine if an insufficient amount of water is being supplied to the equipment.

1. Confirm the filter pump is on.
2. If a multiple-speed filter pump is being used, run filter pump at a higher speed. Do not exceed maximum flow rate for the model.
3. Confirm water is not being diverted away from the heat pump.
 - See "Water Flow Rates" on page 11.
 - See "Adjusting Water Flow Using ΔT (Delta-T)" on page 13.
4. The water pressure switch may be incorrectly calibrated.
 - See "Adjusting Water Pressure Switch" on page 14.

Heat and Cool Units (Reversing)

Place heat pump in heating mode and perform the following troubleshooting.

1. Check for proper fan operation. If fan is not operating, contact AquaCal® Technical Support.
2. Check for obstructed air flow around the heat pump.
 - See "Clearances" on page 5.
3. Check for dirty or blocked evaporator coil.
 - See "Cleaning Equipment After Installation" on page 53.
4. Check for signs of heavy ice buildup on the coil.

LP5 SYSTEM LOCKOUT

ISSUE

The heat pump has locked due to five low-pressure faults during one call for heating or cooling.

RESOLUTION

1. Deactivate then reactivate power to the heat pump to clear error.
2. Troubleshoot the low-pressure issue causing the error.
 - See "LOW PRESSURE FAULT" on page 59.

MULTI-UNIT COMM FAULT

ISSUE

Slaved heat pump is not receiving a signal from the master heat pump.

RESOLUTION

1. Confirm master heat pump is operating correctly. If, for example, no power is supplied to the master heat pump, an error will appear on the slaved heat pumps.
2. Confirm heat pump is properly connected and configured to a master unit.
 - See "Connecting Multiple Heat Pumps (Master / Slaved)" on page 36.

OTA SYSTEM LOCKOUT

ISSUE

A malfunction has occurred that could allow the water temperature to surpass a safe level. An installed "Over Temperature Alarm" kit has disabled the system.

- See "Over Temperature Alarm Kit" on page 71 for more information.

RESOLUTION

Call for service.

SMART COMM FAULT

ISSUE

Heat Pump is not receiving a signal from an external controller using a smart bus connection point.

RESOLUTION

1. Confirm a smart bus external controller is being used.
 - If not, set external controller mode to "none" instead of "SMART".
 - See "Configure for Smart Bus Controller" on page 26.
2. Confirm connection points from external controller to heat pump are correctly configured.
 - See "Connecting Smart Bus Controllers" on page 23.
3. If using a smart bus external controller, confirm the controller is correctly set to send signals to the heat pump. See manuals or guides provided with external controller.

WATER TEMP SENSOR SHORT or WATER TEMP SENSOR OPEN

ISSUE

Shorted or open water sensor.

RESOLUTION

A qualified technician should replace the water sensor.

2.2 Issues and Resolutions



WARNING

Failure to heed the following may result in injury or death.

- Repairs must not be attempted by untrained or unqualified individuals.
- The heat pump contains refrigerant under pressure. Repairs to the refrigerant circuit must not be attempted by untrained or unqualified individuals. Service must be performed only by qualified HVAC technicians. Recover refrigerant before opening the system.

NOTICE

Failure to heed the following may result in damage to equipment.

- Service by unauthorized personnel will void the factory warranty.

Please perform the following troubleshooting.

For further assistance, please see *"Contacting AquaCal AutoPilot, Inc." on page 1.*

Blank Display

ISSUE

The Heat Pump may have an incoming power problem.

RESOLUTION

Confirm electrical power is being supplied to heat pump from electrical disconnect(s).

Display Panel Not Responding

ISSUE

The heat pump's display panel will not respond to user input.

RESOLUTION

1. If heat pump display shows "**UNDER REMOTE CONTROL**", use external control device to control heat pump.
2. If needed, check with external controller manufacturer for further assistance using that device.

Displays "DEFROSTING"**ISSUE**

The heat pump has sensed the coil is icing up. See "Ice Forming on the Heat Pump" on page 66. No action is required.

RESOLUTION**Heat Only Units - Passive Defrost**

When ice starts to form on the coil, the compressor will stop operating while the fan continues to operate.

- The coil will begin to warm to the surrounding air temperature. When the coil's temperature rises above 38° F, the compressor is restarted and heating resumes.
- If the coil's temperature remains below 38° F, the compressor will remain off.

Cool Only Units - Passive Defrost

When ice starts to form on the coil, the compressor will stop operating while the fan continues to operate.

- The coil will begin to warm to the surrounding air temperature. When the coil's temperature rises above 38° F, the compressor is restarted and cooling resumes.
- If the coil's temperature remains below 38° F, the compressor will remain off.

Heat and Cool Units - Active Defrost

Hot refrigerant gas will be sent through the coil to rapidly remove ice or frost.

During this process, the melting of the ice may appear as steam coming off the heat pump. This is normal.

Displays "NO SYSTEM FIRMWARE"**ISSUE**

The heat pump has encountered a software error.

RESOLUTION

Call for service.

Displays "NO POOL/SPA WATER FLOW"**ISSUE**

Low or no water detected. This is normal when circulation pump is deactivated.

RESOLUTION

1. Confirm the filter pump is on.
2. If a multiple-speed filter pump is being used, run at a higher speed to determine if the error persists. Do not exceed maximum flow rate for your model.
3. Confirm water is not being diverted away from the heat pump.
 - See "Water Flow Rates" on page 11.
 - See "Adjusting Water Flow Using ΔT (Delta-T)" on page 13.

Displays "SET TO SWITCH REMOTELY"

ISSUE

If when pressing the "Pool / Spa" button the display flashes the message "**SET TO SWITCH REMOTELY**", the heat pump is using a remote relay switch or a 3-wire controller.

RESOLUTION

- The Pool and Spa thermostat automatically switch when using these modes.
- Manual operation will not be available when using these external devices. No action is required.

Displays "SET UNIT MODEL NUMBER"

ISSUE

The heat pump has encountered a software error.

RESOLUTION

- The model number and serial number will need to be reentered into the system. The system will then operate as normal.
- If the issue reoccurs, please contact AquaCal® Technical Support.

Heat Pump Not Running

ISSUE

The heat pump will not run.

RESOLUTION

1. Confirm equipment is receiving power. Is the heat pump display illuminated?
 - If not, confirm the main breaker (located at the power supply panel) and the disconnect switch (located near the heat pump) are both turned on.
 - If the display still does not illuminate, it is recommended that the heat pump installer or electrician confirm the heat pump is receiving power.
2. Confirm correct mode is selected.
3. Confirm thermostat is set correctly.
 - When heating the water is desired, the thermostat should be set above the current water temperature.
 - When cooling the water is desired, the thermostat should be set below the current water temperature.
4. If an error code is displayed, diagnose and correct the cause of the code.
 - See "Fault Codes" on page 55.
5. If the heat pump is using an external controller, the heat pump may not be set correctly to accept the controller's signal.

Heat Pump's Tripping Breaker

ISSUE

The heat pump breaker(s) keeps tripping.

RESOLUTION

1. If AquaCal® heat pumps have been connected to each other using a multiple heat pump configuration, the configuration may be incorrect. Please confirm settings or contact installer of equipment.
 - See "Connecting Multiple Heat Pumps (Master / Slaved)" on page 36.
2. Have an electrician confirm breakers are correct type, in good condition, and properly sized for the heat pump.

Heat Pump Won't Shut Off

ISSUE

The heat pump will not deactivate.

RESOLUTION

PLEASE NOTE

When heat pump is set to off, the display will show the current water temperature or no water flow indicator.

1. Confirm the correct mode has been set on the heat pump.
2. Confirm the heat pump has reached the desired temperature set on the thermostat. The heat pump will continue to run until the set temperature is reached.
3. If the heat pump is using an external controller, it may not be set correctly. See external controller's manual.

Heat Pump Is Running, Not Heating

ISSUE

The heat pump is running. But the water is not heating.

RESOLUTION

1. If the heat pump is using an external controller, confirm it is set correctly.
 - See operation manual for operating heat pump with an external controller.
 - If the heat pump is still not running correctly with this device, contact the installer of the external controller device or the device's manufacturer for further assistance.
2. Confirm heat pump mode is set to heat.
3. Confirm thermostat is set to the desired water temperature.
4. Confirm valves are positioned to heat the correct body of water (either the pool or the spa). If heating a spa that overflows into a pool, confirm the spa is isolated when being heated (not flowing into the pool).
5. Confirm heat pump is transferring heat into the water.
 - Measure the temperature of air discharge coming out of the heat pump fan. If discharge air is between 8° to 10° colder than the outside ambient air, the heat pump is moving heat into the water.
6. If an error code is displayed, diagnose and correct cause of code.
 - See "Fault Codes" on page 55.
7. Confirm that filter pump has a sufficient run-time. The heat pump will not run (or heat the water) without water flow.
 - See "Heating Recommendations" on page 69.
1. If heating a spa, deactivate air blower or venturi (if equipped) to allow for quicker heating times. For pools, deactivate water features, such as slides, waterfalls, or fountains to allow water to retain heat. Use of a liquid pool blanket product, such as an Aqua Blanket™, can also compensate for excessive heat loss.
 - See "Liquid Blankets" on page 71.

ISSUE

The heat pump is running. But the water is not cooling.

RESOLUTION

1. If the heat pump is using an external controller, confirm the heat pump is programmed properly to allow for cooling.
2. Confirm the heat pump mode is set to cool.
3. Confirm the thermostat is set below the current water temperature.
4. Confirm valves are positioned to cool the correct body of water (either the pool or the spa). If cooling a spa that overflows into a pool, confirm the spa is isolated when being cooled (not flowing into the pool).
5. If an error code is displayed, determine and correct the condition causing the code.
 - See "Fault Codes" on page 55.
6. Confirm heat pump is transferring heat out of the water.
 - Measure the temperature of air discharge coming out of heat pump's fan. If the air is between 8° to 10° warmer than the outside ambient air, the heat pump is moving heat out of the water.
7. Confirm that filter pump has a sufficient run-time. The heat pump will not run (or cool the water) without water flow.

Ice Forming on the Heat Pump

ISSUE

When conditions are too cold for proper operation, the heat pump will enter a defrost mode. This prevents ice from building up on the evaporator coil.

RESOLUTION

Heat Only Units:

- The heat pump may develop a fine layer of white frost on the outside coil before entering the defrost mode. This is normal.
 - See "Displays Defrosting" on page 62.
- If heavy ice (not frost) starts to build up, shut off the heat pump. Contact the installer or manufacturer.
- If the ambient air temperature will be falling below 32° F for more than 8 hours, winterize equipment.

Cool Only Units

- The heat pump may enter defrost mode if the water flow rate falls below the acceptable range. See "Water Flow Rates" on page 11.
- If the ambient air temperature will be falling below 32° F for more than 8 hours, winterize equipment.

Heat and Cool Units (with Active Defrost or "Icebreaker"):

- During freezing conditions, pool or spa heating will continue. Frost or ice may develop during the "countdown" to the active defrost (up to 50 minutes). This is normal. See "Displays Defrosting" on page 62.
- The heat pump will enter an "active defrost" stage to remove the accumulated frost and ice.
 - Be sure to observe the unit for at least 50 minutes. If it has not entered an active defrost cycle, call for service.

TIP:

The heat pump can be manually set to defrost by temporarily switching to the cooling mode until the ice or frost melts.

- If the ambient air temperature is (or will be) falling below 32° F for more than 8 hours, winterize equipment.

"Pool / Spa" Button Will Not Work

ISSUE

The "Pool / Spa" button is disabled if the following devices have been configured on the heat pump.

RESOLUTION

- A 2-wire external controller.
- A 3-wire external controller.
- An external flow switch.

ISSUE

The water may be normal condensation produced as a by-product of the heat pump's refrigeration process.

The heat pump can produce up to 8 to 10 gallons of condensation per hour depending on the humidity of the ambient air. Determine if the water is condensation or a possible leak.

RESOLUTION

1. Deactivate heat pump, leaving the filter pump on. After several hours, determine if water is still coming from the heat pump.
2. If using chlorine or bromine as a pool / spa sanitizer, test the water around the heat pump using a test strip. If the test strip indicates that chlorine or bromine is present, a leak may exist.

PLEASE NOTE -

If desired, a kit is available to re-direct condensation water away from the heat pump.

- See "Condensation Drain Kit (# STK0202)" on page 70.

3 - Appendix

IN THIS SECTION:

- 3.1 Identifying Model Specifications 68
- 3.2 Weights 69
- 3.3 Heating Recommendations 69
- 3.4 Cooling Recommendations 70
- 3.5 Available Accessories 70

3.1 Identifying Model Specifications

1. Find Data Plate - The data plate is usually posted on the side of the equipment or the inside of the heat pump's access plate.
2. Find the model number on the data plate. The first letters and numbers indicate the model type.
3. The complete model number identifies the equipment's specifications.

Data Plate Example

MINIMUM CIRCUIT AMPACITY MADE IN THE USA
 ELEC. SERVICE: VOLTS PH HZ
 MAXIMUM TIME DELAY FUSE OR HACR BREAKER 5
 COMPRESSOR VOLTS R.L.A. L.R.A.
 FAN MOTOR VOLTS H.P. F.L.A.
 REFRIGERANT: Circuit - Factory charged Only oz/Kg
 Tested to psig High side / psig Low side
 OUTDOOR UNIT
 AQUA CAL, INC
 A TEAM HORNER COMPANY
 2737 24TH STREET NORTH
 ST. PETERSBURG, FL 33713
 FACTORY SERVICE
 727-523-5642
 MODEL NUMBER
IIIBAR CODEIII
 SERIAL NUMBER
IIIBAR CODEIII

Model Number Example

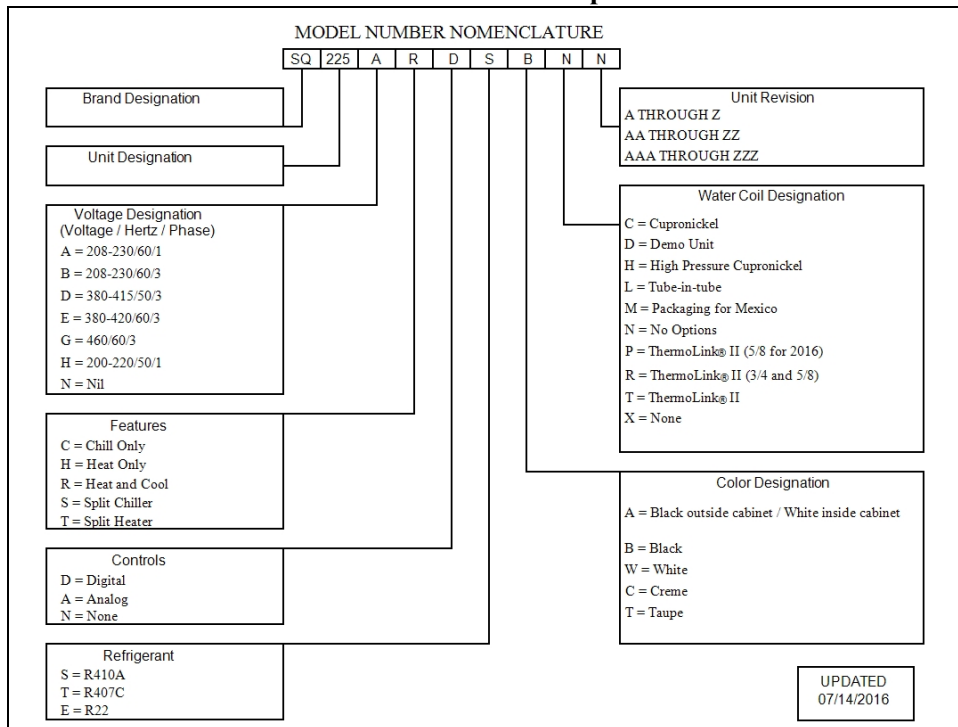

3.2 Weights

NOTE:

Specifications subject to change.

Model Type	Model Number	Install Weight
TropiCal®	T035	180 Pounds
TropiCal®	T055	180 Pounds
TropiCal®	T075	200 Pounds
TropiCal®	T090	255 Pounds
TropiCal®	T115	259 Pounds
TropiCal®	T135	287 Pounds
HeatWave SuperQuiet®	SQ120R	268 Pounds
HeatWave SuperQuiet®	SQ125	268 Pounds
HeatWave SuperQuiet®	SQ145	328 Pounds
HeatWave SuperQuiet®	SQ166R	328 Pounds
HeatWave SuperQuiet®	SQ225	328 Pounds
TropiCool®	TC500	215 Pounds
TropiCool®	TC1000	285 Pounds
TropiCool®	TC1500	328 Pounds

3.3 Heating Recommendations

The following recommendations will reduce the amount of time required to heat a pool. **If unsure of equipment heating capability, review equipment data plate.** See "Identifying Model Specifications" on page 68.

1. Confirm heat pump mode has been set to heating mode.
2. Set a desired temperature (set point) for the water.
3. Temporarily set the filter pump for continuous operation.
 - This will allow the Heat Pump the time required to heat the water at start-up.
 - After the water has reached the desired temperature, reset the filter pump to normal operating time-frames.
4. Use a pool cover or blanket to reduce heating time.

3.4 Cooling Recommendations

The following recommendations will reduce the amount of time required to cool a pool or cold plunge application. **If unsure of equipment cooling capability, review equipment data plate.** See "Identifying Model Specifications" on page 68.

1. Confirm heat pump mode has been set to cooling mode.
2. Set thermostat to desired water temperature.
3. Temporarily set the filter pump for continuous operation.
 - This will allow the Heat Pump the time required to cool the water at start-up.
 - After the water has reached the desired temperature, reset the filter pump to normal operating time-frames.

3.5 Available Accessories

Accessories may be purchased through an authorized dealer of AquaCal® products.

Bypass Valve Kit (# STK0135)

- When high flow rates are outside recommended specifications, please use this kit or an alternative bypass valve system.
- This kit can be used to control excessive water flow through the heat pump. It provides automatic flow adjustments for most applications.



Condensation Drain Kit (# STK0202)

- Used when condensation water flow must be directed to a specific location.



Call Flex Accessory (# 0030-LEDS)

- This accessory will override a circulation pump to provide water to the heat pump when the set temperature is not met.

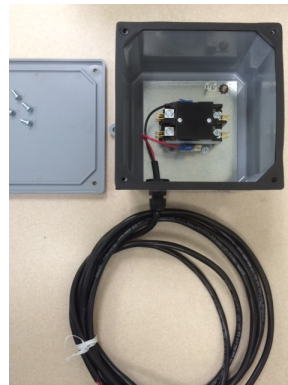

Grid Flow Switch (# 0040S)

- Used for automatic pool / spa thermostat switching.
- This switch can also be used in place of the water pressure switch. This may be needed when the pool / spa elevation is higher than the heat pump. A higher elevation of the water can cause a false signal to the heat pump; indicating water is flowing through the heat pump when it isn't.
- This kit is not to be used on applications exceeding 50 PSI.

©2012 APC



Liquid Blankets

- An invisible liquid heat barrier designed to retain heat and extend the swimming season.
- AquaCal® recommends [Lo-Chlor®](#) Aqua Blanket™.



Over Temperature Alarm Kit

- This kit is an additional safety device. It disables the heat pump if any malfunction occurs that allows the water temperature to surpass a safe level.
- This kit is strongly recommended for all spa applications.
 - Single Phase Heat Pump - (# STK0221)
 - Three Phase Heat Pump - (# STK0222)

Plumbing Unions

- 2 Inch Unions - (# PLS2627)



Temperature Port Kit (# STK0096)

- This port can be used to adjust water flow using Delta-T.
- The kit comes with port, installation components, and a temperature probe.



